

MultiRAE Series

User's Guide



Rev J
September 2017
P/N: M01-4003-000

IMPORTANT!

MultiRAE-series instruments use instrument firmware version 1.50/sensor firmware version 1.50.

IMPORTANT! BUMP TEST THE MONITOR BEFORE EACH DAY'S USE

Prior to each day's use, every gas detection monitor should be bump tested to confirm the response of all sensors and activation of all alarms by exposing the monitor to a concentration of target gas that exceeds the low alarm set point. A bump test is also recommended if the monitor has been subjected to physical impact, liquid immersion, an Over Limit alarm event, or custody changes, or anytime the monitor's performance is in doubt.

To ensure greatest accuracy and safety, only bump test and calibrate in a fresh air environment.

The monitor should be calibrated every time it does not pass a bump test, but no less frequently than every six months, depending on use and exposure to gas and contamination, and its operational mode.

- Calibration intervals and bump test procedures may vary due to national legislation.
- Honeywell recommends using calibration gas cylinders containing the gas that is appropriate to the sensor you are using, and in the correct concentration.

Product Registration

Register your product online by visiting:

<http://www.raesystems.com/support/product-registration>

By registering your product, you can:

- Receive notification of product upgrades or enhancements
- Be alerted to Training classes in your area
- Take advantage of RAE Systems special offers and promotions

Contents

1	Features Comparison.....	10
2	Standard Contents	11
3	General Information.....	12
3.1	Key Features	13
4	User Interface.....	15
4.1	Display Overview.....	15
4.1.1	Mesh Radio Status Indicator Icons.....	15
4.1.1.1	Wi-Fi Status Indicator Icons	17
4.1.2	Keys And Interface	18
4.1.3	LCD Flip.....	18
4.1.4	Key Remapping When LCD Is Flipped.....	19
4.2	Screen Display For Various Numbers Of Active Sensors.....	20
4.3	Menus	21
4.3.1	Hygiene Mode.....	21
4.3.2	Search Mode	22
5	Wireless Control And Submenus.....	24
6	Point-To-Point Wired Connection	25
6.1	Using ProRAE Studio II To Set P2P Operation	25
6.1.1	License Key Installation	25
6.1.2	Enabling P2P	29
6.2	Connecting A MultiRAE To A PC To Enable Point-To-Point Operation.....	30
6.3	Charging With The MultiRAE Desktop Cradle.....	31
6.4	Automatic PID Cleaning.....	32
6.5	Charging With The Travel Charger	32
6.6	Carrying The MultiRAE In A Vehicle	33
6.6.1	Truck Mount Installation.....	33
6.6.2	Using The Truck Mount With The 12-Volt Travel Charger	33
6.7	Charging With The AutoRAE 2	34
6.8	Replacing A Battery.....	34
6.9	Charging Batteries With A MultiRAE Battery Charger	35
6.9.1	Assembly	35
6.9.2	Charging.....	36
6.10	Battery States.....	37
6.11	Alkaline Battery Pack.....	37
7	Turning The MultiRAE On And Off	38
7.1	Turning The MultiRAE On.....	38
7.2	Turning The MultiRAE Off.....	38
7.3	Testing Alarm Indicators	39
7.4	Glance Mode	39
7.5	Pump Status.....	40
7.6	Calibration Status	40
7.7	Bump Status.....	41
7.8	Toggle Display: Alternating Between Correction Factor And Reading.....	41
7.9	Enabling Benzene Sep-Tube Cartridge Tutorial (MultiRAE Benzene).....	41
8	Modes Of Operation.....	42
8.1	Hygiene Operation Mode.....	42
8.2	Search Operation Mode.....	42
8.3	Benzene-Specific Mode (MultiRAE Benzene Only).....	42
8.3.1	Separation Tube Cartridge Installation.....	43
8.3.2	Measurement.....	45
8.4	Basic User Mode	49
8.5	Advanced User Mode	49
9	Programming.....	49

9.1	Enter Programming In Advanced Mode	49
9.2	Enter Programming In Basic Mode	50
9.3	Menus And Submenus	51
9.3.1	Editing And Selecting Parameters And Sensors	51
9.3.2	Calibration	52
9.3.3	Bias & Equilibration For Liquid O ₂ And Other Biased Sensors	52
9.3.3.1	Fresh Air	52
9.3.3.2	Multi Sensor Span	54
9.3.3.3	Single Sensor Zero	54
9.3.3.4	Single Sensor Span	55
9.3.3.5	MultiRAE Benzene Calibration Process	56
9.3.3.6	Multi Sensor Bump	57
9.3.3.7	Single Sensor Bump	59
9.3.3.8	Cal. Reference.....	60
9.3.3.9	Change Cal. Gas	60
9.3.3.10	Multi Cal Select.....	60
9.3.3.11	Change Span Value.....	61
9.3.3.12	Change Span2 Value.....	61
9.3.4	Calibrating A PH ₃ Sensor Using H ₂ S Calibration Gas	62
9.3.5	Measurement.....	63
9.3.5.1	Sensor On/Off.....	63
9.3.5.2	Change Meas. Gas.....	63
9.3.5.3	Measurement Units.....	64
9.3.6	Alarms	65
9.3.6.1	Alarm Limits.....	65
9.3.6.2	Alarm Mode	65
9.3.6.3	Alarm Settings	65
9.3.6.4	Comfort Beep	65
9.3.6.5	Man Down Alarm	66
9.3.6.6	Man Down Messaging (Wi-Fi-Equipped Instruments Only)	67
9.3.6.7	Panic Alarm (Wi-Fi-Equipped Instruments Only)	68
9.3.7	Quick Access Menu (Wi-Fi-Equipped Instruments Only).....	69
9.3.8	Datalog	72
9.3.8.1	Clear Datalog.....	72
9.3.8.2	Datalog Interval.....	72
9.3.8.3	Sensor Selection.....	72
9.3.8.4	Data Selection	73
9.3.8.5	Datalog Type	73
9.3.8.6	Memory Full Action	73
9.3.9	Wireless.....	74
9.3.9.1	Radio ON/OFF.....	74
9.3.9.2	Roaming	74
9.3.9.3	PAN ID	75
9.3.9.4	Channel	75
9.3.9.5	Join Network.....	76
9.3.9.6	Interval.....	76
9.3.9.7	Off Network Alarm	77
9.3.9.8	Factory Reset	77
9.3.10	Wireless (Instruments Equipped With Wi-Fi Only).....	78
9.3.11	Monitor.....	80
9.3.11.1	LCD Contrast.....	80
9.3.11.2	Operation Mode.....	80
9.3.11.3	Pump Speed.....	81
9.3.11.4	Zero At Start	81

9.3.11.5	Fast Startup	81
9.3.11.6	Temperature Units	81
9.3.11.7	Language.....	81
9.3.11.8	Site ID.....	81
9.3.11.9	User ID	81
9.3.11.10	Date Format	81
9.3.11.11	Date	82
9.3.11.12	Time Format.....	82
9.3.11.13	Time	82
9.3.11.14	User Mode.....	82
9.3.11.15	Backlight.....	82
9.3.11.16	LCD Flip	82
10	Policy Enforcement	83
10.1	Setting Policy Enforcement.....	83
10.1.1	Using The AutoRAE 2 Automatic Test And Calibration System	83
10.1.2	Using The MultiRAE Desktop Cradle Or Travel Charger.....	87
10.2	Deactivating Policy Enforcement	88
10.2.1	AutoRAE 2 Cradle	88
10.2.2	MultiRAE Desktop Cradle Or Travel Charger	88
11	Calibration And Testing	90
11.1	Manual Alarms Test.....	90
11.2	Bump Testing And Calibration	90
11.2.1	MultiRAE Equipped With A Pump	90
11.2.2	MultiRAE Lite Diffusion Model (No Pump).....	91
11.2.3	Bump (Functional) Testing.....	91
11.2.4	Testing The Gamma Radiation Sensor	93
11.3	Zero/Fresh Air Calibration.....	94
11.3.1	Zero Calibration For A CO2 Sensor	94
11.3.2	Zero Calibration For Parts-Per-Billion (ppb) Sensor	94
11.3.3	Fresh Air Calibration	94
11.3.4	Single-Sensor Zero Calibration	95
11.4	Span Calibration	95
11.5	Three-Point Calibration For Enhanced Linearity With Extended- Range And ppb PID Sensors.....	95
11.5.1	Enabling 3-Point Calibration Via ProRAE Studio II.....	96
11.5.2	Multi-Sensor Span Calibration	98
11.5.3	Single-Sensor Span Calibration	99
12	MultiRAE Pro Normal & Gamma Operation.....	100
12.1	Normal Mode For Simultaneous Radiation & Gaseous Threat Measurements.....	100
12.2	Gamma Radiation-Only Measurement Mode.....	100
12.2.1	Activating Gamma-Only Measurement Mode.....	100
12.2.2	Exiting Gamma-Only Measurement Mode	101
13	Datalog Transfer, Monitor Configuration, and Firmware Upgrades Via Computer	102
13.1	Downloading Datalogs And Performing PC-Based Instrument Configuration And Firmware Upgrades.....	102
13.1.1	Desktop Cradle or Travel Charger	102
13.1.2	AutoRAE 2.....	103
13.1.3	Upgrading Firmware – Two Steps.....	103
14	Maintenance.....	105
14.1	Removing/Installing The Rubber Boot	105
14.2	Replacing The Filter(s)	105
14.3	Replacing The Gas Inlet Adapter (Pumped Versions Only).....	106
14.4	Removing/Cleaning/Replacing Sensor Modules	106
14.5	Removing/Cleaning/Replacing A PID (Pumped Versions Only)	107

14.6	Replacing The Pump	109
15	Alarms Overview	110
15.1	Alarm Signals	110
15.2	Changing The Alarm Mode	110
15.3	Alarm Signal Summary	111
15.3.1	Hygiene Mode.....	111
15.3.2	Search Mode	112
15.3.3	General Alarms.....	113
16	Troubleshooting	114
17	Pump Stall Threshold Adjustment	115
17.1	Entering Diagnostic Mode To Set The Pump Stall Threshold.....	115
17.2	Selecting The Pump Stall Threshold Method	115
17.3	Setting Pump Stall Threshold Values – Dynamic Method	116
17.4	Setting Pump Stall Threshold Values – Static Method	117
17.4.1	Stall High Threshold Setting – Static Method	118
17.4.2	Verifying the Stall High Setting.....	118
17.4.3	Stall Low Threshold Setting - Static	118
17.5	Verifying the Stall Low Setting - Static	119
18	Configuring Wi-Fi Communication (Wi-Fi-Equipped Instruments Only)	120
18.1	Setting Wi-Fi Communication Parameters In ProRAE Studio II.....	120
18.1.1	Wi-Fi Power	121
18.1.2	Address	121
18.1.3	Channels And Security	122
18.1.4	Scan Channel List.....	122
18.1.5	Security Mode.....	122
18.1.6	Security Key	123
18.1.7	SSID	123
18.1.8	Location Anchor SSID.....	123
18.1.9	ProRAE Guardian IP.....	123
18.1.10	ProRAE Guardian UDP Port.....	123
18.2	Configuring Messaging	124
19	Specifications	125
20	Technical Support	130



Read Before Operating

This manual must be carefully read by all individuals who have or will have the responsibility of using, maintaining, or servicing this product. The product will perform as designed only if it is used, maintained, and serviced in accordance with the manufacturer's instructions.

CAUTION!

Never operate the monitor when the cover is removed. Remove the monitor rear cover or battery only in an area known to be non-hazardous.

ANY RAPID UP-SCALE READING FOLLOWED BY A DECLINING OR ERRATIC READING MAY INDICATE A GAS CONCENTRATION BEYOND UPPER SCALE LIMIT, WHICH MAY BE HAZARDOUS.

TOUTE LECTURE RAPIDE ET POSITIVE, SUIVIE D'UNE BAISSSE SUBITE AU ERRATIQUE DE LA VALEUR, PEUT INDIQUER UNE CONCENTRATION DE GAZ HORS GAMME DE DÉTECTION QUI PEUT ÊTRE DANGEREUSE

ONLY THE COMBUSTIBLE GAS DETECTION PORTION OF THIS INSTRUMENT HAS BEEN ASSESSED FOR PERFORMANCE.

UNIQUEMENT, LA PORTION POUR DÉTECTOR LES GAZ COMBUSTIBLES DE CET INSTRUMENT A ÉTÉ ÉVALUÉE.

CAUTION: BEFORE EACH DAY'S USAGE, SENSITIVITY OF THE LEL SENSOR MUST BE TESTED ON A KNOWN CONCENTRATION OF METHANE GAS EQUIVALENT TO 20 TO 50% OF FULL-SCALE CONCENTRATION. ACCURACY MUST BE WITHIN 0 AND +20% OF ACTUAL. ACCURACY MAY BE CORRECTED BY CALIBRATION PROCEDURE.

ATTENTION: AVANT CHAQUE UTILISATION JOURNALIERE, VERIFIER LA SENSIBILITE DU CAPTEUR DE LIE AVEC UNE CONCENTRATION CONNUE DE METHANE EQUIVALENTE DE 20 A 50% DE LA PLEINE ECHELLE. LA PRECISION DOIT ETRE COMPRISE ENTRE 0 ET 20% DE LA VALEUR VRAIE ET PEUT ETRE CORRIGEE PAR UNE PROCEDURE D'ETALONNAGE.

CAUTION: HIGH OFF-SCALE READINGS MAY INDICATE AN EXPLOSIVE CONCENTRATION.

ATTENTION: DES LECTURES HAUTES ET HORS D'ECHELLE PEUVENT INDIQUER DES CONCENTRATIONS DE GAZ INFLAMMABLES

CAUTION: SUBSTITUTION OF COMPONENTS MAY IMPAIR INTRINSIC SAFETY.

Note: Users are recommended to refer to ISA-RP12.13, Part II-1987 for general information on installation, operation, and maintenance of combustible gas detection instruments.

The MultiRAE multi-gas detector must be calibrated if it does not pass a bump test, or at least once every 180 days, depending on use and sensor exposure to poisons and contaminants.

SPECIAL CONDITIONS FOR SAFE USE

1. The PGM-62xx shall only be fitted with RAE Systems Battery Pack type M01-3051-000, M01-3053-000, M01-3055-000, or M01-3056-000 or Battery Adapter M01-3052-000 or M01-3054-000 fitted with Duracell MN1500 batteries.
2. The PGM62xx shall only be charged outside hazardous areas.
3. No precautions against electrostatic discharge are necessary for portable equipment that has an enclosure made of plastic, metal, or a combination of the two, except where a significant static-generating mechanism has been identified. Activities such as placing the item in a pocket or on a belt, operating a keypad or cleaning with a damp cloth, do not present a significant electrostatic risk. However, where a static-generating mechanism is identified, such as repeated brushing against clothing, then suitable precautions shall be taken, e.g., the use of anti-static footwear.







The model PGM62xx is certified according to the IECEx scheme, ATEX and cCSAus (for US and Canada). PGM62xx is intrinsically safe and may be used in hazardous locations. **SUBSTITUTION OF COMPONENTS MAY IMPAIR INTRINSIC SAFETY.**

MARKING

The product is marked with the following information:

RAE SYSTEMS
3775 N. 1st. St., San Jose
CA 95134, USA

Type PGM62x0, PGM 62x6, PGM 62x8
Serial No/matrix: XXX-XXXX-000

IECEx SIR 11.0069X, Ex ia IIC T4 Ga Ex ia I Ma (PGM62x0/PGM62x6) Ex ia d IIC T4 Gb Ex ia I Ma (PGM62x8)	 2460 SIRA 11ATEX2152X  II 1G Ex ia IIC T4 Ga  I M1 Ex ia I Ma (PGM62x0/PGM62x6)  II 2G Ex ia d IIC T4 Gb  I M1 Ex ia I Ma (PGM62x8)	 _{US} Exia Cl I, Dv 1 Gr. A, B, C, D, T4; Cl II, Dv 1 Gr. E, F, G; T85°C C22.2 No 152-1984 ISA-12.13.01-2000	IECEx TSA 13.0021X / ANZEx 13.3023X Ex ia IIC T4 Ga Ex ia I Ma (PGM62x0/PGM62x6) Ex ia d IIC T4 Gb Ex ia I Ma (PGM62x8)
---	--	---	--

Warnings: Understand manual first before operating.

Warning: Do not change batteries in hazardous location.
Do not mix old/new or different type of batteries

PGM62x0: Use only RAE Systems battery pack, PN: M01-3051-000, M01-3056-000, or M01-3052-000.

PGM62x6/62x8: Use only RAE Systems battery pack, PN: M01-3053-000, M01-3055-000, or M01-3054-000.

Um: 20V

-20° C ≤ Tamb ≤ +50° C

FCC Part 15 Statement

This device complies with Part 15 of the FCC rules. Operation is subject to the following two conditions: (1) This device may not cause harmful interference, and (2) this device must accept any interference received, including interference that may cause undesired operation.

Operation Area and Conditions

Hazardous Areas classified by Zones

PGM62x0/PGM62x6 are intended to be used in hazardous areas zone 0, zone 1 or zone 2, and PGM62x8 in hazardous areas zone 1 or zone 2 within the temperature range of -20° C to +50° C, where gases of explosion groups IIA, IIB or IIC and T4 may be present.

Hazardous Areas classified by Divisions

PGM62x0/PGM62x6/PGM62x8 are intended to be used in hazardous areas classified for Class I & II Div. 1 or 2, within the temperature range of -20° C to +50° C, where gases of explosion groups A, B, C, D, T4; Groups E, F, G; T85°C.

WARNINGS:

1. NDIR sensors shall not be installed in PGM62x0 or PGM 62x6 models.
2. NDIR LEL sensors shall not be installed in PGM62x8 diffusion models bearing **cCSAus** logo.

Proper Product Disposal At End Of Life



The Waste Electrical and Electronic Equipment (WEEE) directive (2002/96/EC) is intended to promote recycling of electrical and electronic equipment and their components at end of life. This symbol (crossed-out wheeled bin) indicates separate collection of waste electrical and electronic equipment in the EU countries. This product may contain one or more Nickel-metal hydride (NiMH), Lithium-ion, or Alkaline batteries. Specific battery information is given in this user guide. Batteries must be recycled or disposed of properly.





At the end of its life, this product must undergo separate collection and recycling from general or household waste. Please use the return and collection system available in your country for the disposal of this product.

Sensor Specifications, Cross-Sensitivities, And Calibration Information

For information on sensor specifications, cross-sensitivities, and calibration information, refer to RAE Systems Technical Note TN-114: Sensor Specifications And Cross-Sensitivities (available for free download from www.raesystems.com/downloads/tech-notes). All specifications presented in this Technical Note reflect the performance of stand-alone sensors. Actual sensor characteristics may vary when the sensor is installed in different instruments. As sensor performance may change over time, specifications provided are for brand-new sensors.

1 Features Comparison

This chart shows the differences between the various MultiRAE models. (For information on the MultiRAE MX, refer to the MultiRAE MX data sheet and User's Guide.)

	MultiRAE Pro	MultiRAE	MultiRAE Lite	MultiRAE Benzene
Appearance				
Gamma Radiation Sensor	Yes			
ppb PID (10.6 eV; 0.01 - 2,000 ppm; 10 ppb resolution)	Yes			
High-Range ppm PID (10.6 eV; 0.1 - 5,000 ppm; 0.1 ppm res.)	Yes	Yes		
ppm PID (10.6 eV; 1 - 1,000 ppm; 1 ppm resolution)			Pumped Only	
ppm PID (9.8 eV; 0.1 - 2,000 ppm; 0.1 ppm resolution)				Yes
20+ Electrochemical Sensors	Yes	Yes	Yes	Yes
ETO-C Extended-range Sensor			Diffusion Only	
Hydrogen (H ₂) Sensor			Diffusion Only	
H ₂ S, HR Extended-range Sensor			Diffusion Only	
Catalytic %LEL Sensor	Yes	Yes	Yes	Yes
Combustible NDIR Sensors (%LEL or %Vol. CH ₄)	Yes	Yes	Pumped Only	
CO ₂ NDIR Sensor	Yes	Yes	Yes	
Integrated Wireless Modem (Optional)	Yes	Yes	Yes	Yes
Integrated Wi-Fi Modem (Optional)	Yes	Yes	Yes	Yes
Sampling	Pumped	Pumped	Pumped or Diffusion	Pumped
IP Rating	IP-65	IP-65	IP-65 (Pumped) IP-67 (Diffusion)	IP-65
Default Rubber Boot Color	Black	Yellow	Yellow	Red
Automatic Test and Calibration System	AutoRAE 2	AutoRAE 2	AutoRAE 2, pumped version only	AutoRAE 2

2 Standard Contents

The MultiRAE is available in four configurations, each with different kits, outlined below.

	MultiRAE Lite Pumped*	MultiRAE Lite Diffusion*	MultiRAE	MultiRAE Pro	MultiRAE Benzene
Monitor with sampling mode, sensors, battery, and wireless options as specified and protective rubber boot, external filter, and belt clip installed	Pumped Yellow Rubber boot	Diffusion Yellow Rubber boot	Pumped Yellow Rubber boot	Pumped Black Rubber boot	Pumped Red Rubber boot
Travel Charger/PC communications adapter	Yes	Yes	Yes	Yes	Yes
AC adapter	Yes	Yes	Yes	Yes	Yes
Desktop charging / PC communications cradle	No	No	No	Yes	No
Alkaline battery adapter	Included with rechargeable configurations only	Included with rechargeable configurations only	Yes	Yes	Yes
PC communication cable	Yes	Yes	Yes	Yes	Yes
Calibration adapter	Yes	Yes	Yes	Yes	Yes
6" flexible probe	No	No	Yes	Yes	No
3 spare external filters	Yes	No	Yes	Yes	Yes
10 charcoal filters (reduce CO sensor's cross-sensitivity to VOCs)	Yes	No	Yes	Yes	Yes
RAE-Sep Tube Cartridges					Yes
PID sensor cap removal tool	Yes	No	Yes	Yes	Yes
PID zeroing charcoal filter	No	No	No	Yes	Yes
Toolkit	Yes	Yes	Yes	Yes	No
QuickStart Guide	Yes	Yes	Yes	Yes	Yes
CD with documentation	Yes	Yes	Yes	Yes	Yes
CD with ProRAE Studio II instrument configuration and data management software	Yes	Yes	Yes	Yes	Yes
Technical Note TN-106 with ionization energies and correction factors for 300+ VOCs	No	No	Yes	Yes	Yes
Calibration and test certificate	Yes	Yes	Yes	Yes	Yes
Warranty/registration card	Yes	Yes	Yes	Yes	Yes
Cardboard box with a colorful sleeve	Yes	Yes	No	No	No
Hard transport case	No	No	Yes	No	Yes
Pelican case	Optional	Optional	Optional	Yes	Optional

3 General Information

The MultiRAE is a family of multi-threat gas detectors that combine continuous monitoring capabilities for volatile organic compounds (VOCs), toxic and combustible gases, and radiation, with Man Down Alarm functionality in one highly portable instrument. MultiRAE monitors offer an industry-leading selection of interchangeable field-replaceable electrochemical, combustible, infrared, PID (photoionization detector), and gamma radiation sensors to fit a wide variety of applications. The MultiRAE family's wireless capability elevates worker protection to the next level by providing safety officers real-time access to instrument readings and alarm status from any location for better visibility and faster response.

Notes:

- NDIR combustible sensors are not supported on the diffusion version with CSA certification.
- The PID sensor requires a pumped configuration.
- If a % Vol. NDIR sensor is installed in an instrument, a catalytic bead %LEL sensor must also be installed in the instrument for CSA certification.
- MultiRAE Benzene is designed specifically for use with the benzene-specific cartridge.

IMPORTANT!

The benzene-specific cartridge cannot be used on other MultiRAE models.

3.1 Key Features

- All-in-one continuous monitoring capabilities for gamma radiation, VOCs, oxygen, toxic and combustible gases, for a total of up to six threats at a time
- Highly customizable with over 25 field-interchangeable intelligent sensor options
- Wireless access to real-time instrument readings and alarm status from any location through ProRAE Guardian Real-Time Wireless Safety System
- Unmistakable five-way local and remote wireless notification of alarm conditions, including Man Down Alarm
- Large graphical display with easy-to-use, icon-driven user interface
- Simple maintenance with easily accessible sensors, pump, and plug-and-play battery
- Fully automated charging, data management, bump testing and calibration with AutoRAE 2

MultiRAE With Pump, front view

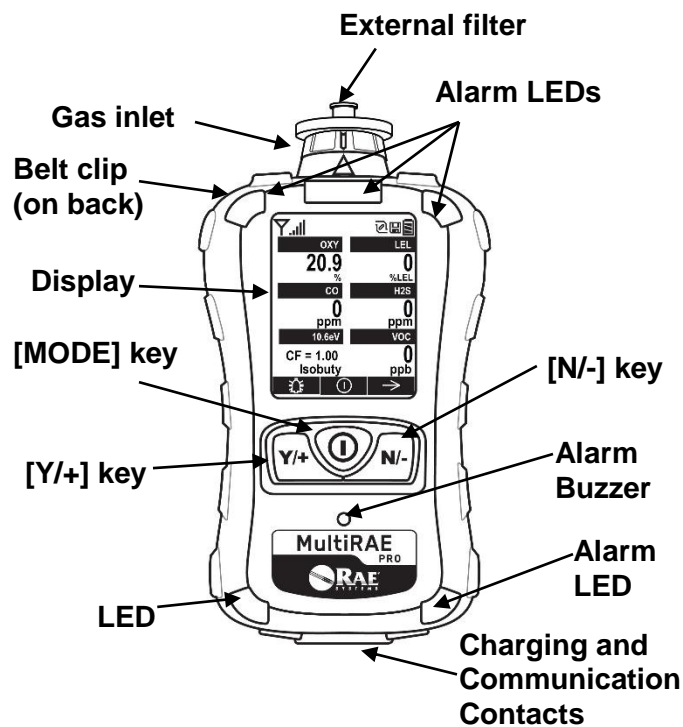

**MultiRAE Lite Diffusion Model,
rear view**

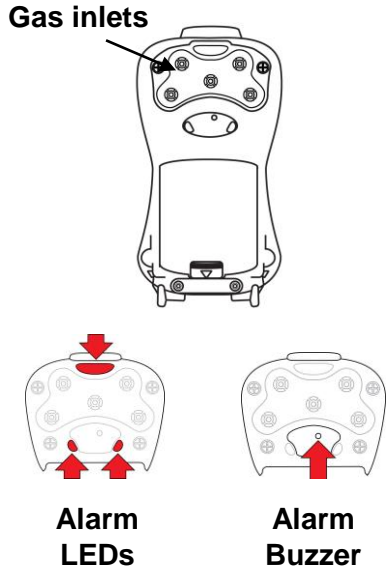

**MultiRAE Benzene with
RAE-Sep Tube Cartridge**

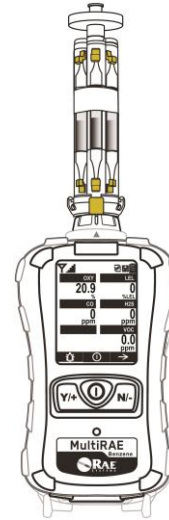

Note: The front of the diffusion model of the MultiRAE Lite is the same as the pumped model, but instead of a single gas inlet at the top, there are five inlets on the back side, as well as an extra alarm buzzer and LEDs.

The belt clip on the back of the pump-equipped MultiRAE can be swiveled for carrying it at different angles:

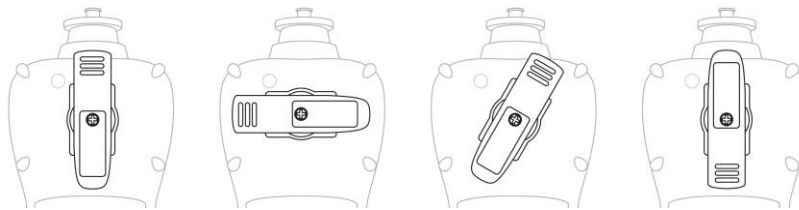

4 User Interface

The MultiRAE’s user interface consists of the display, alarm LEDs, an alarm buzzer, and three keys.

4.1 Display Overview



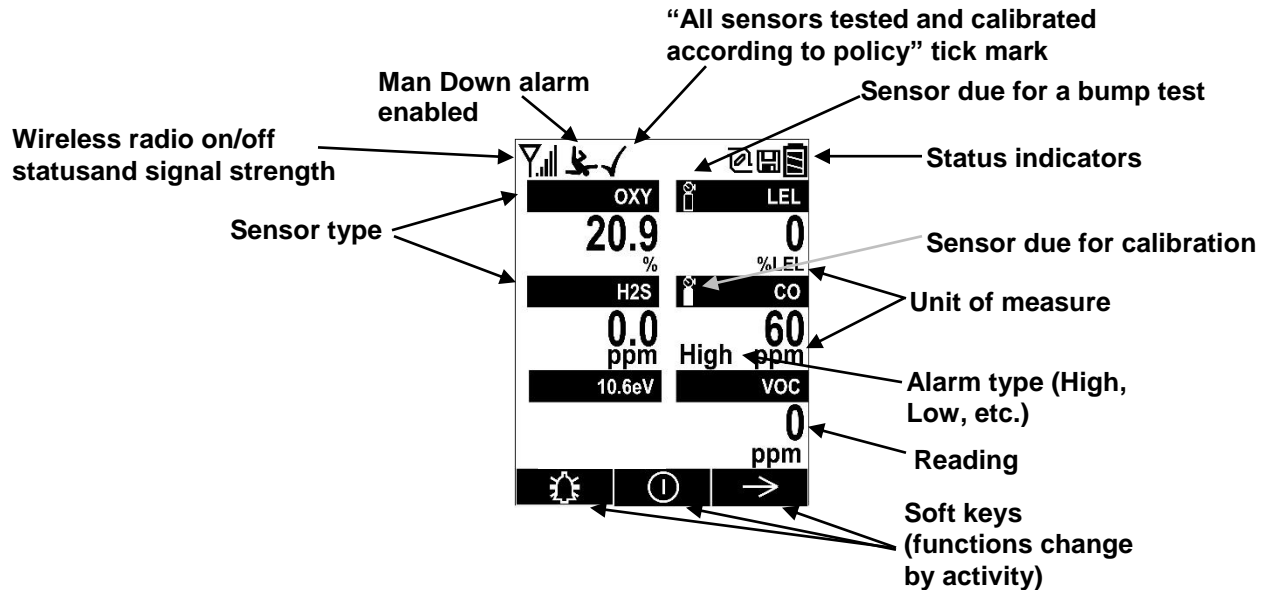







The LCD display provides visual feedback that includes the sensor types, readings, alarm status, battery condition, and other information.



4.1.1 Mesh Radio Status Indicator Icons















Along the top of most screens are status indicators that tell you whether a function is operating and/or its strength or level. Wi-Fi status icons are shown on page 17.

Icon	Function
	Wireless status: the Mesh radio is on (blinks when network is not found)
	Wireless status: the Mesh radio is off
	Mesh radio signal 0% to 20%
	Mesh radio signal 21% to 40%
	Mesh radio signal 41% to 80%
	Mesh radio signal 81% to 100%
	Roaming status: “R” blinks when trying to find a network (replaced by antenna when Roaming is off and if radio-enabled)
	Roaming status: “R” solid when network communication established (replaced by antenna when Roaming is off)
	Roaming status: Power is off
	Roaming status: Network joined, received signal strength very low (0% to 20%)
	Roaming status: Network joined, received signal strength low (21% to 40%)

Icon	Function
	Roaming status: Network joined, received signal strength medium (41% to 60%)
	Roaming status: Network joined, received signal strength good (61% to 80%)
	Roaming status: Network joined, received signal strength very good (81% to 100%)
	Pump status (only on pump-equipped models)
	Datalogging status (shown when datalogging is on, blank when off)
	Battery status (three segments show battery charge level)
	Man Down alarm enabled
	Sensor due for calibration
	Sensor due for a bump test
	“All sensors tested and calibrated to policy” tick mark (all sensors have been bump tested and calibrated; no sensor is overdue for a bump test or calibration according to the intervals configured on the instrument)

4.1.1.1 Wi-Fi Status Indicator Icons

Wi-Fi has its own set of icons, which includes messaging icons.

Icon	Description	Notes
	Wi-Fi is connected to the wireless access point	If the instrument's Wi-Fi is not associated with the access point,  blinks at 1-second intervals
	Wi-Fi received signal strength 0% to 20%	
	Wi-Fi received signal strength 21% to 40%	
	Wi-Fi received signal strength 41% to 80%	
	Wi-Fi received signal strength 81% to 100%	
	Access Point is connected and communication has been established with ProRAE Guardian	The  icon if there is communication with ProRAE Guardian within 4 minutes. Otherwise, it blinks at 1-second intervals.
	There are unread messages	If the instrument's Wi-Fi and access point are not associated and there are unread messages,  blinks at 1-second intervals
	Message has been read	
	Message is unread	
	Message received	
	Send/Sent message	
	Panic alarm	

4.1.2 Keys And Interface

The MultiRAE has three keys:



In addition to their labeled functions, [Y/+], [MODE], and [N/-] act as “soft keys” that control different parameters and make different selections within the instrument’s menus. From menu to menu, each key controls a different parameter or makes a different selection.

Three panes along the bottom of the display are “mapped” to the keys. These change as menus change, but at all times the left pane corresponds to the [Y/+] key, the center pane corresponds to the [MODE] key, and the right pane corresponds to the [N/-] key. Here are examples that show the relationships of the keys and functions:

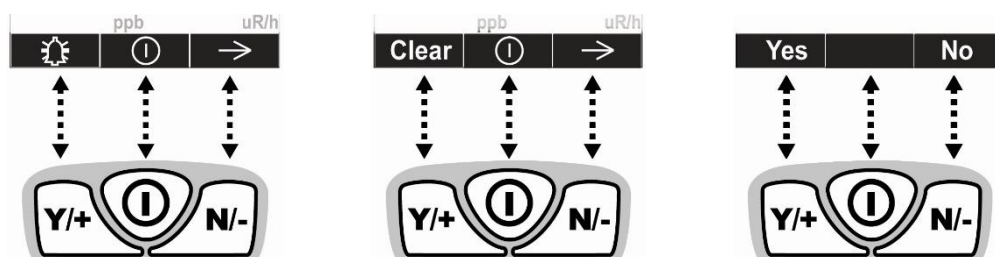

In addition to the functions described above, any of the keys can be used to manually activate display backlighting. Press any key when the backlighting is off to turn it on. A subsequent key press is required to carry out an actual function corresponding to that key.

4.1.3 LCD Flip

The MultiRAE senses its vertical/horizontal orientation, and can automatically flip the display 180 degrees, making it easy to read if the MultiRAE is upside down. (You can turn this feature on or off in Programming Mode, under “Monitor/LCD Flip.”)

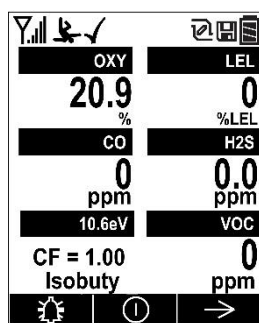

As the MultiRAE is tilted, the gravity sensor detects its orientation and inverts the screen when it is past its horizontal position.

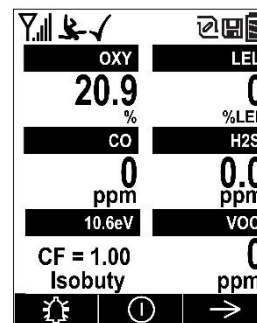

4.1.4 Key Remapping When LCD Is Flipped

When the instrument is inverted and the LCD flips, the keys are remapped to the functions shown on the screen.

Display with MultiRAE in non-inverted position:

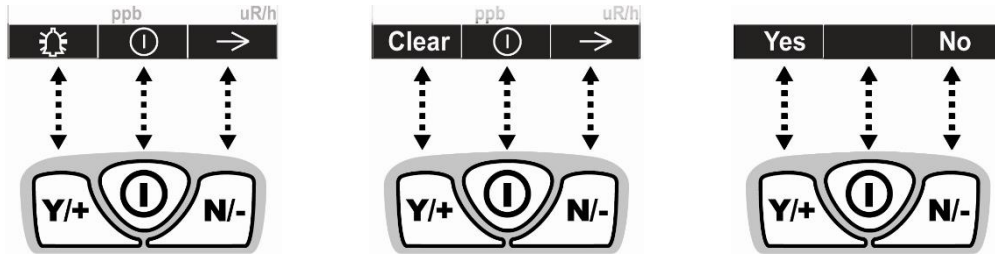

Display with MultiRAE inverted:

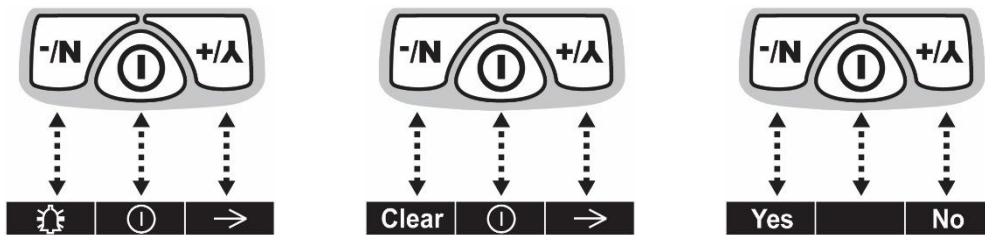

4.2 Screen Display For Various Numbers Of Active Sensors

The MultiRAE family of instruments can display readings from one to six sensors (including dual sensors), depending on the configuration. In order to maximize readability and the amount of information shown, the display is automatically reconfigured, according to the number and types of sensors in the MultiRAE.

If the configuration includes five sensors, and one of them is a PID, then the lamp value is shown, along with the currently applied correction factor (CF) and measurement gas.

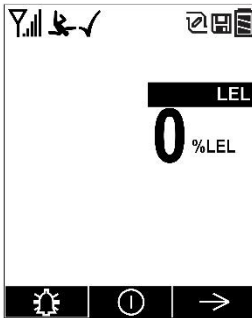

One sensor.



Two sensors.

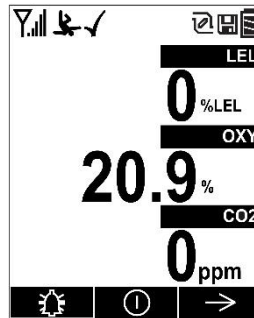

Three sensors.

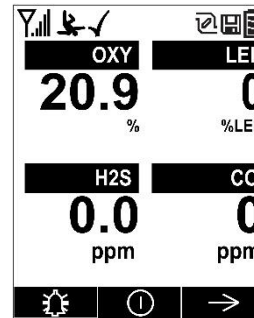

Four sensors.

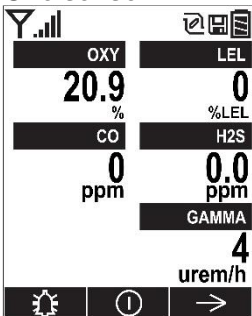

Five sensors, including Gamma radiation sensor.

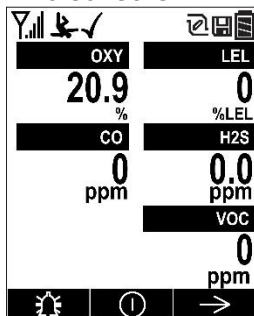

Five sensors, including PID, showing lamp type, correction factor, and measurement gas.

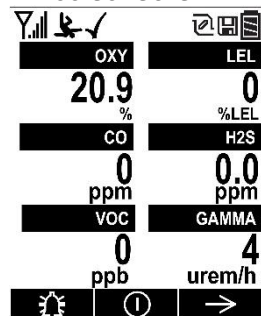

Six-sensor configuration with CO+H₂S combo sensor.

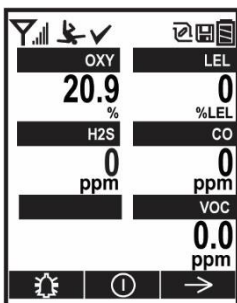

When used in TVOC mode, MultiRAE Benzene shows all sensor readings continuously

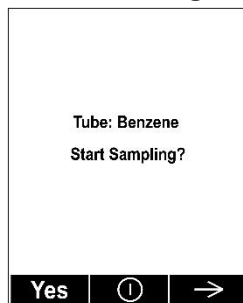

In benzene mode, the display prompts for snapshot sampling.

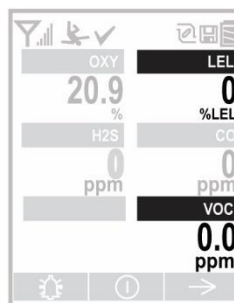

Toggle Display is standard on MultiRAE Benzene to alternate between LEL and VOC reading and their CFs. ProRAE Studio II allows other MultiRAE instruments to toggle the display for PID and LEL readings and CFs.

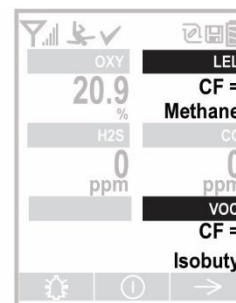

4.3.2 Search Mode

Notes:

- If the instrument is not equipped with a VOC sensor (PID), or is not equipped with an LEL sensor, then screens for those sensors (VOC Gas Status and LEL Gas Status, respectively) are not shown.
- If the Peak or Min is cleared, the Average is also cleared. In addition, each cycle through the main screen after they are cleared will route from “Ready... Start sampling?” directly to Date and Time if you press [N/-] (see red line in diagram below), until you perform a new sample. Also, if you start sampling again and stop sampling, clear the Peak, or clear the Min, it advances to Date and Time, as well.

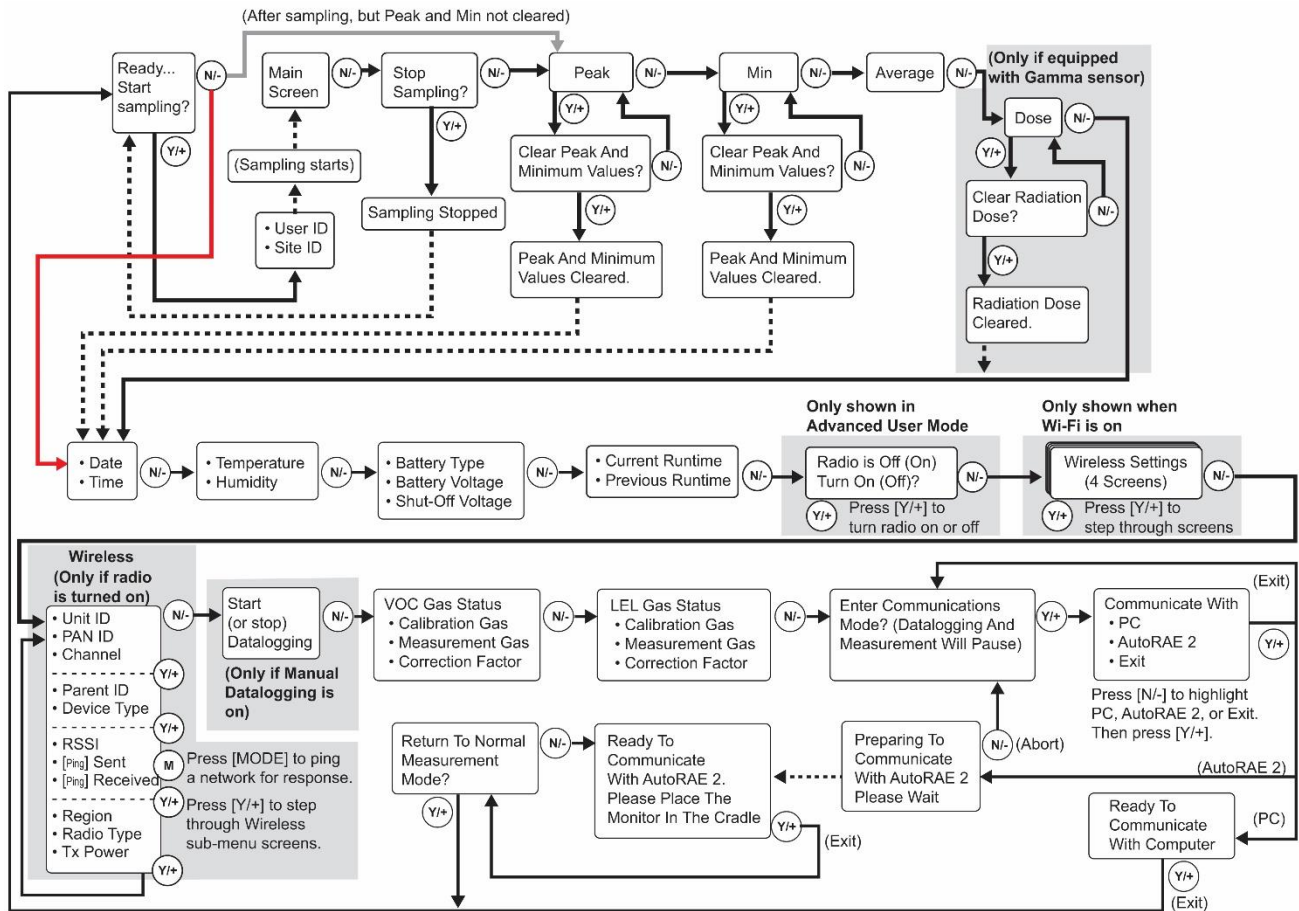

Note: Dashed line indicates automatic progression.

MultiRAE Benzene (TVOC and Benzene Modes)

Notes:

- When prompted to start benzene sampling, there is an option to view a tutorial. This is helpful if you do not have this User's Guide in the field or if you are unfamiliar with how to ready the MultiRAE Benzene for benzene sampling. If the option is not shown, follow the procedure on page 41.
- Benzene sampling is done in a "snapshot," meaning that the instrument does not continuously monitor for benzene.

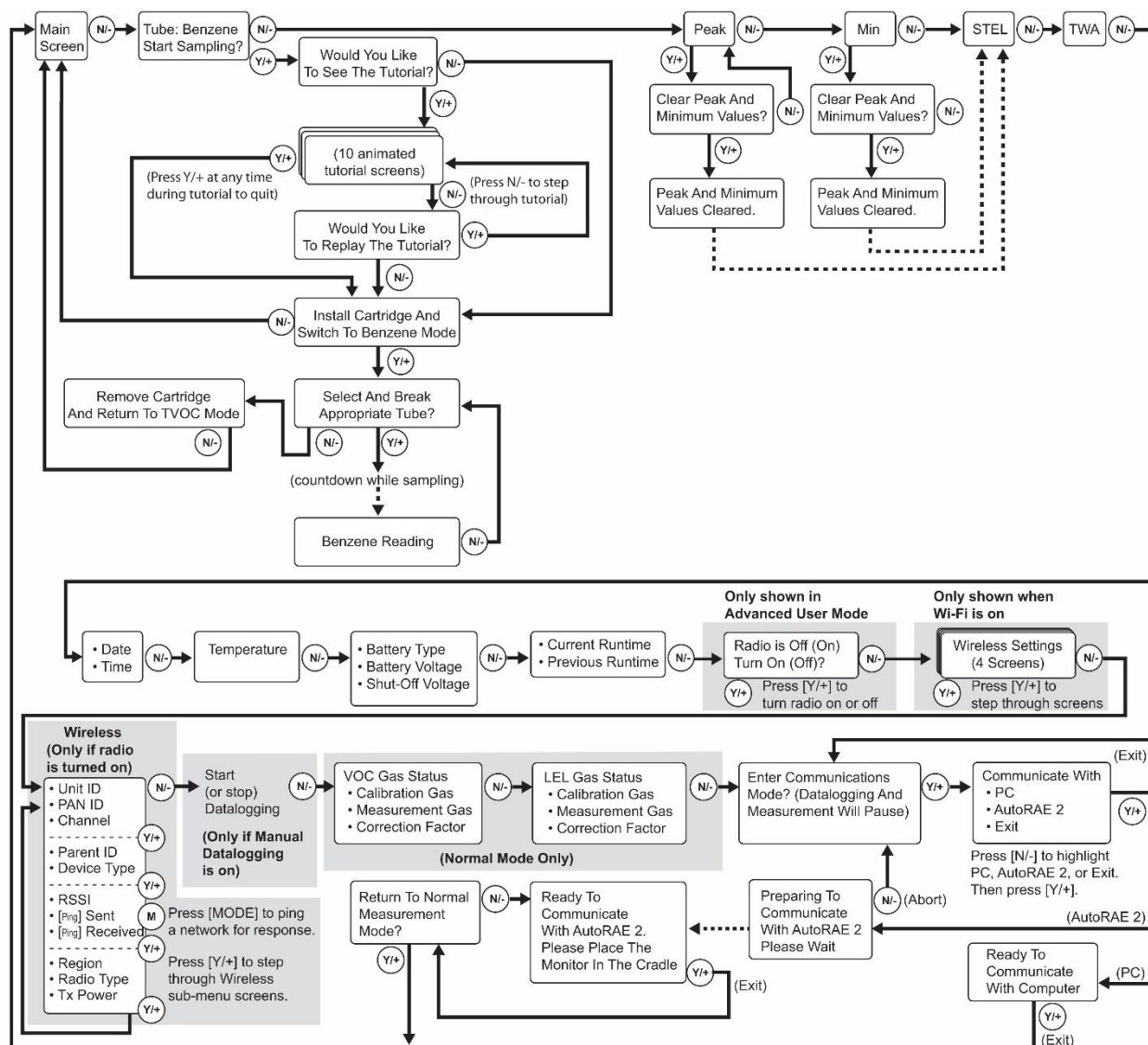

Note: Dashed line indicates automatic progression.

5 Wireless Control And Submenus

When you step through the main menu, as shown in the previous diagrams, there are screens for wireless communication.

Note: These are only present if the MultiRAE is equipped with a wireless module.

At the Radio On/Off screen, you can turn the radio on or off, if the MultiRAE is in Advanced User Mode. The radio turns off instantly, but turning on the radio takes a few seconds, so you see a screen that indicates the radio is being turned on. If the instrument is in Basic User Mode, the option for turning the radio on or off does not appear (you can turn it on or off in Programming Mode).



All wirelessly equipped models, except those with Wi-Fi, also have the following screens. At the Wireless screen, you can check communication with other wireless devices and get other useful information about the wireless settings. The Wireless menu is divided into a sequence of four “pages,” each presenting different information. As you press [Y/+] on each of the “pages,” you advance to the next one.

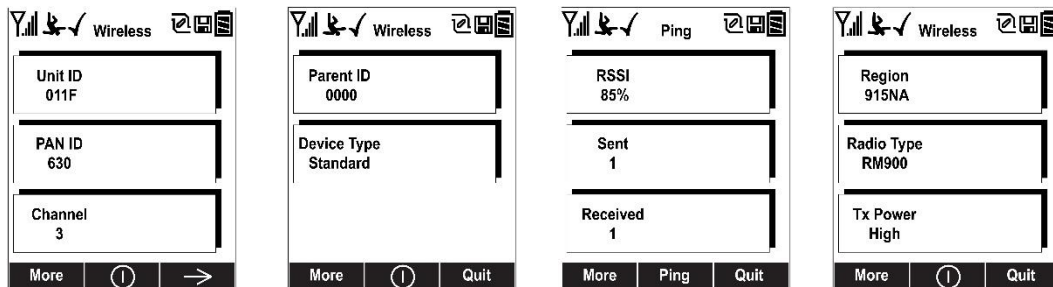

Unit ID (unique identifier of the instrument’s radio), Pan ID, and Channel are read-only parameters that help you to check whether the instrument’s wireless settings are correct (very helpful for troubleshooting).

The next “page,” Parent ID and Device Type are also read-only. The Parent ID (the ID of the “Parent” wireless device to which the monitor is connected) is not changeable. The device type tells you that it is “Standard,” meaning it transmits and receives.

The third “page” is labeled “Ping,” where you can check the signal strength via RSSI (received signal strength indication) and “ping” the network to confirm an active two-way communication network. Each time you press [MODE] to “ping” the network, a number of sends is included under “Sent.” If the network receives the signal and sends one back, which is in turn received by the MultiRAE, then a number is added under “Received.”

The fourth “page” includes the type of transmitter (Region), Radio Type (model), and Tx Power (transmission power). These are primarily for diagnostics and troubleshooting.

When you reach the fourth “page,” you can wrap around to the first one by pressing [Y/+]. Otherwise, you can press [N/-] to quit, which advances to the next screen.

6 Point-To-Point Wired Connection

The MultiRAE can communicate with other devices through P2P (point-to-point) wiring. Turning on P2P requires connecting the MultiRAE with a computer running ProRAE Studio II software and toggling P2P on. **Note:** When P2P is active, the wireless modem (if one is installed in the MultiRAE) is disabled.

Refer to page 102 for detailed information on connecting the MultiRAE to a PC running ProRAE Studio II.

6.1 Using ProRAE Studio II To Set P2P Operation

Important! P2P (point-to-point) operation requires a License Key.

If you do not have a License Key for enabling P2P (point-to-point) communication on your MultiRAE, contact Honeywell Customer Support and order one or more P2P License Keys for MultiRAE. Customer Support will need a Purchase Order for MultiRAE P2P license, and will generate the necessary number of License Keys and send them to you via email.

6.1.1 License Key Installation

After receiving the License Key for MultiRAE P2P via email from Honeywell Customer Support, do the following:

1. Use the supplied PC Communications Cable (USB to mini-USB cable) to connect the MultiRAE's Desktop Cradle, AutoRAE 2 Cradle, or Travel Charger to a PC where the License Key will be stored. The PC must have ProRAE Studio II (version 1.11.2 or higher) installed.
2. Turn on the MultiRAE. Make sure it is running in Normal mode (with the main measurement screen showing).
3. Insert the MultiRAE in the Desktop Cradle or AutoRAE 2 Cradle, or connect it to the Travel Charger.
4. Activate the PC communications mode on the MultiRAE by pressing [N/-] repeatedly, starting from the main measurement screen until you reach the "Communicate With Computer?" screen.
5. Press [Y/+]. Measurement and datalogging stop, and the instrument is now ready to communicate with the PC. The display now says "Ready To Communicate With Computer."
6. Start up the ProRAE Studio II software, enter its password, and detect the instrument following the directions provided in the ProRAE Studio II User's Guide.

The main ProRAE Studio screen is shown:



7. Under “Operation,” select “License.”

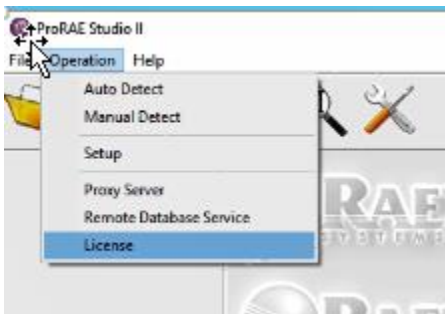

8. When the License Wizard appears, click “Next.”

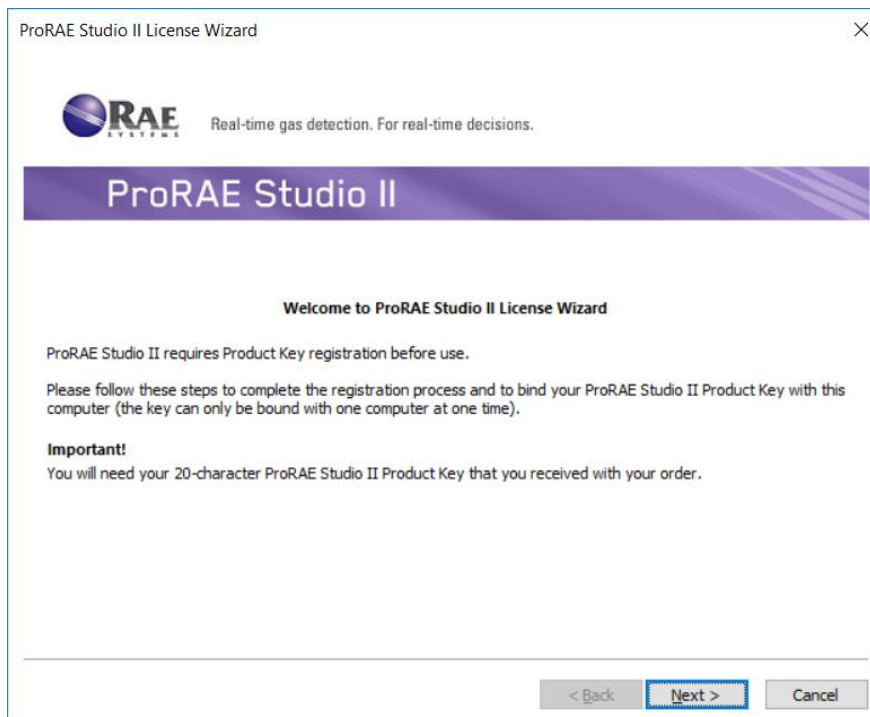

9. Enter the 20-character License Key that you received from Honeywell’s Customer Support.
10. Click “Next.”

The License Wizard connects to the License Manager, uploads information, and registers the License Key.

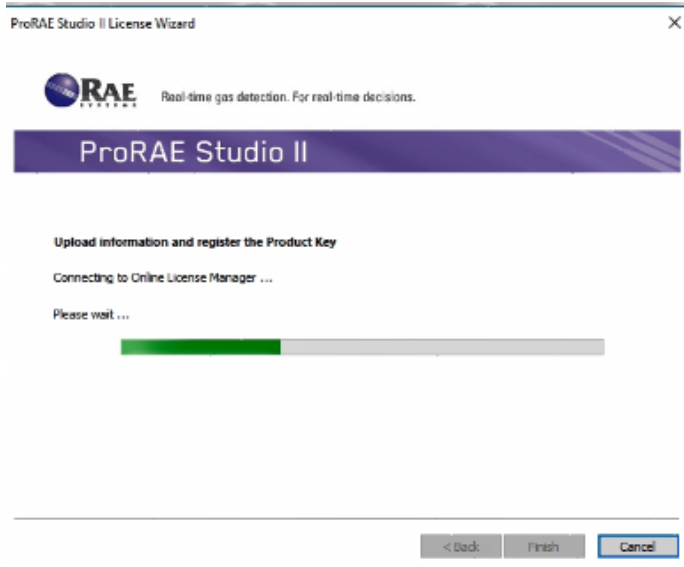

When the License Key is registered, this message is shown:

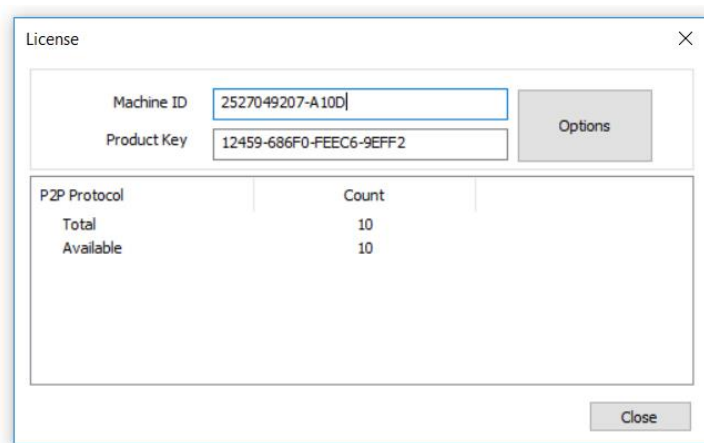

Note: “Count” is the number of subscribed licenses (the number tells how many active licenses are registered). Licenses must stay on this particular computer. They cannot be deactivated from this PC and moved to another. If this computer is lost, stolen, corrupted, or replaced, contact Customer Support.

11. Click “Finish.”

Each time you open ProRAE Studio II and connect to a MultiRAE, the menu item “P2P protocol” appears in the list, and you can enable or disable the feature.

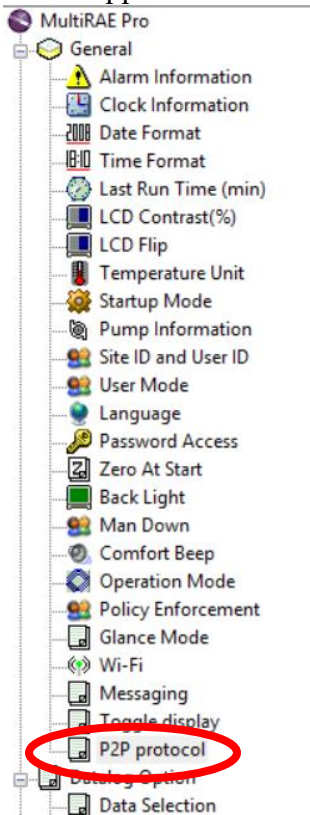

Important! The MultiRAE must have firmware version 1.50 or higher installed in order to enable P2P switch functionality. If the instrument requires an upgrade, follow the MultiRAE Firmware Upgrade Instructions [here](#). Otherwise, skip to the next section.

6.1.2 Enabling P2P

1. With the MultiRAE connected to the PC, establish communication with ProRAE Studio. Refer to page 102 for details.
2. Click “Setup” to download the MultiRAE’s setup data.
3. Click “P2P Protocol” to open the P2P Protocol pane.
4. Click “Enable” to enable P2P, or “Disable” to disable P2P.
5. Click “Set.”
6. Click the “Upload” icon to upload the configuration to the MultiRAE.

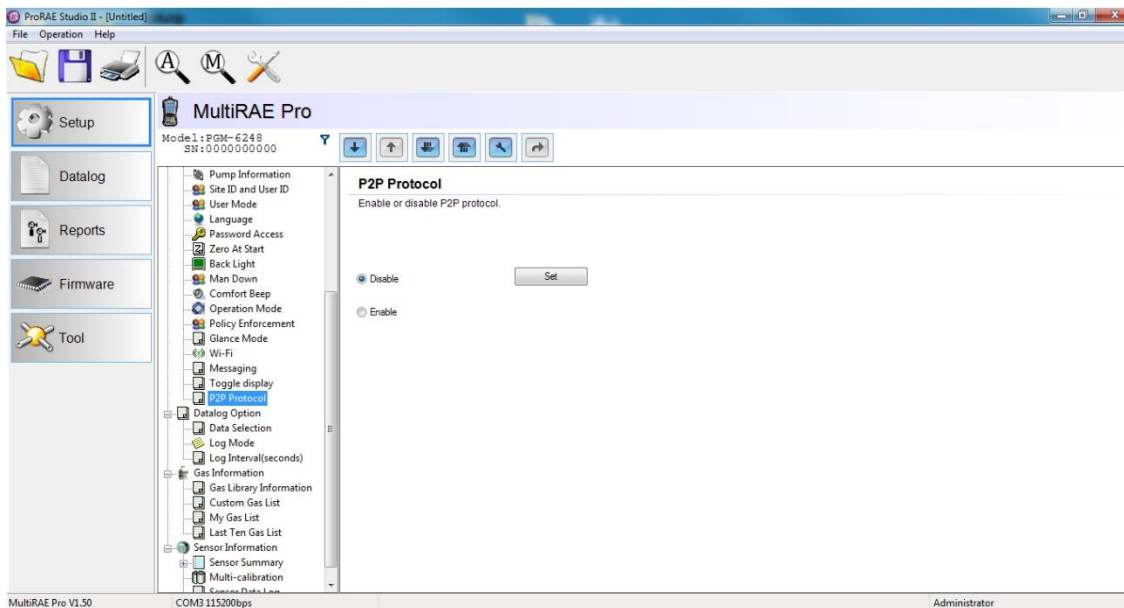

7. When you are done, press [Y/+] to exit the PC communications mode on the MultiRAE. The instrument returns to operating in Normal mode.

6.2 Connecting A MultiRAE To A PC To Enable Point-To-Point Operation

Once the MultiRAE is configured for P2P (point-to-point) communication, you must connect it to a PC or other equipment that it will communicate with. Connect the MultiRAE to the computer using the special RS232 Travel Charger and its mini-USB to DB9 cable (the standard MultiRAE Travel Charger and mini-USB-to-USB PC communications cable will not support P2P). If your computer does not have a DB9/RS232 serial port, use the USB-to-Serial Adapter (P/N: 410-0210-000) to connect the mini-USB to DB9 cable to a PC's USB port.

Supply power to the RS232 Travel Charger. Either attach the AC adapter to the RS232 Travel Charger, or plug its USB-A plug into an active USB port on the computer for power. The RS232 Travel Charger will not operate without a power source.

Note: Do not plug in both the USB and the AC adapter at the same time, as this may cause errors. Follow one of the three diagrams below for power and data connection options.

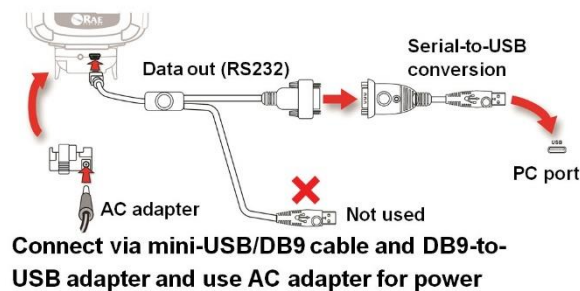
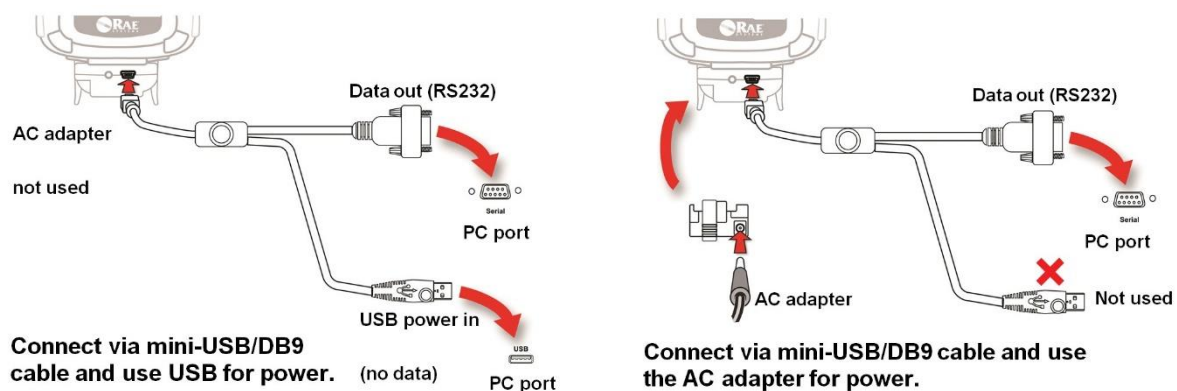

Note: Refer To RAE Systems Technical Note TN-190 for more information on how point-to-point operation works.

7. Battery

Always make sure the batteries are fully charged before using the MultiRAE. Three battery options are available for the MultiRAE (PGM 62x6/62x8):

1. Standard duration rechargeable Li-ion battery (PN: M01-3051-000)
2. Extended-duration rechargeable Li-ion battery delivering 50% more runtime than the standard battery (PN: M01-3056-000)
3. Alkaline battery pack for four standard AA-sized batteries (PN: M01-3052-000)

Its standard or extended-duration batteries are charged inside the instrument by placing the MultiRAE in its cradle or using the Travel Charger. Contacts on the bottom of the instrument meet the cradle's contact pins, transferring power.

Note: Before setting the MultiRAE into its MultiRAE Desktop Cradle or attaching its Travel Charger, visually inspect the contacts to make sure they are clean. If they are not, wipe them with a soft, dry cloth. Do not use solvents or cleaners.

WARNING

To reduce the risk of ignition of hazardous atmospheres, recharge, remove or replace the battery only in an area known to be non-hazardous! Do not mix old and new batteries or batteries from different manufacturers.

6.3 Charging With The MultiRAE Desktop Cradle

Follow this procedure to charge the MultiRAE:

1. Plug the AC/DC adapter into the MultiRAE's Desktop Cradle.
2. Plug the AC/DC adapter into the wall outlet.
3. Place the MultiRAE into the cradle (make sure the bottom of the instrument and the alignment pins on the cradle mate properly) and press down until it is locked in place.

The MultiRAE begins charging automatically. The LED in the cradle should glow red to indicate charging. When charging is complete, the LED in the cradle glows green.

To remove the MultiRAE from the Desktop Cradle, tilt it toward you until it releases, and then lift it up.

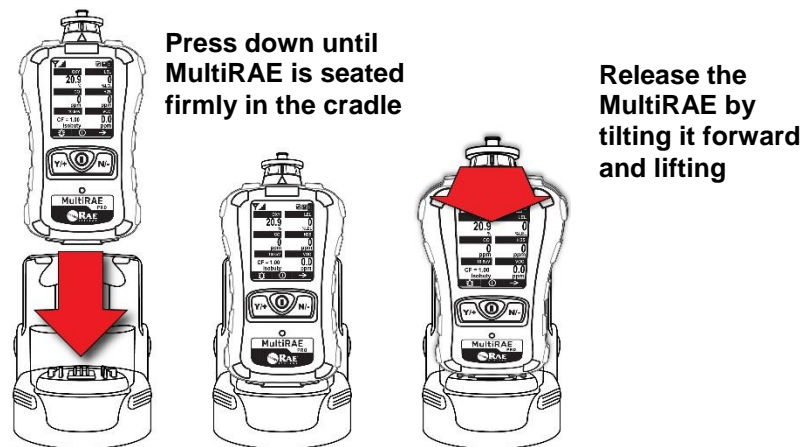

Next, put the plug from the power supply into the jack on the side of the Desktop Cradle:

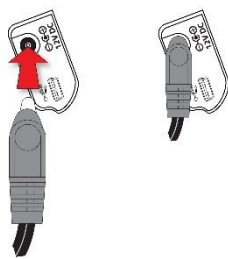

Plug the other end of the charger into a power source.

6.4 Automatic PID Cleaning

MultiRAE products offer auto-cleaning, a unique feature that reduces PID lamp cleaning. When a MultiRAE equipped with a PID lamp is charging in a desktop cradle, truck mount, or AutoRAE 2 cradle (but not a Travel Charger), the PID lamp turns on for two hours and generates a small concentration of ozone. Ultraviolet light and ozone molecules then burn off heavy contaminants that may have built up on the lamp and sensor. Then the pump runs for 20 minutes to exhaust gas contained inside the gas plate. After the pump stops, the battery continues to be charged, if necessary.

Note: This function also works when the instrument is turned off

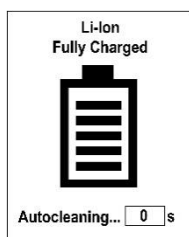

6.5 Charging With The Travel Charger

The Travel Charger is a lightweight portable alternative to the Desktop Cradle for charging and PC communications. Follow these steps to use the Travel Charger.

Before attaching the Travel Charger, check that it is aligned correctly with the base of the MultiRAE. There are two alignment pins on one side and one alignment pin on the other side, designed to mate with matching points on the bottom of the MultiRAE:

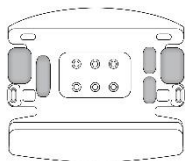

1. Check bottom of MultiRAE Travel Charger's alignment pins for correct orientation with the MultiRAE.

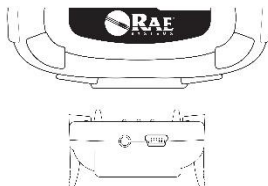

2. Align Travel Charger with bottom of MultiRAE.



3. Press Travel Charger onto bottom of MultiRAE.



4. Make sure the Travel Charger clicks into place and attaches firmly.

Next, put the plug from the power supply into the jack on the side of the Travel Charger:

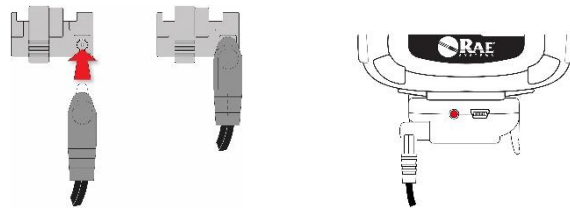

Plug the other end of the charger into a power source (AC outlet or 12VDC mobile power port, depending on the model). When power is applied and the MultiRAE's battery is charging, the LED glows red. The LED glows green when the battery is fully charged.

6.6 Carrying The MultiRAE In A Vehicle

The MultiRAE Truck Mount, used in conjunction with the front part of the Desktop Cradle, provides an NFPA requirement-compliant way to mount and carry the MultiRAE in a vehicle.

CAUTION!

Do not use the Truck Mount in hazardous locations.

6.6.1 Truck Mount Installation

The Truck Mount must be used in conjunction with the front part of the MultiRAE Desktop Cradle. Follow the guidelines below to select the correct mounting hardware for the Truck Mount and install it in your vehicle. Use these dimensions to pre-drill a flat surface to accept the Truck Mount. The maximum screw diameter must not exceed 6.4mm (0.25"). Vertical clearance should be at least 26cm (10").

Letter	Measurement
A	61.6 mm (2.42")
B	96 mm (3.8")
C	113 mm (4.5")
D	150.8 mm (6")

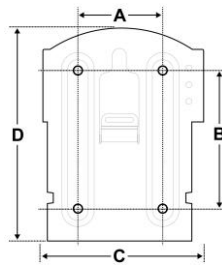

Important!

Make sure that there is sufficient clearance around and above the mounting plate so that the MultiRAE can be easily placed in the cradle and removed.

6.6.2 Using The Truck Mount With The 12-Volt Travel Charger

Slide the cradle into the Truck Mount as shown below. The capture tabs on both sides of the Truck Mount slip into the cradle and lock it in place. Make sure the cradle sits securely in the Truck Mount. (To separate the cradle from the Truck Mount, press the rubber release buttons on both sides of the cradle and pull the cradle free.) Next, insert the straight plug from the 12-volt charging adapter into the port on the side of the Truck Mount/Cradle. Then plug the other end into the 12-volt outlet in the vehicle. **Note:** If the 12-volt charging adapter has an angle ("L"-shaped) plug, follow the Angle-Plug Configuration. This requires inserting the angle plug before placing the cradle into the Truck Mount.

Straight-Plug Configuration

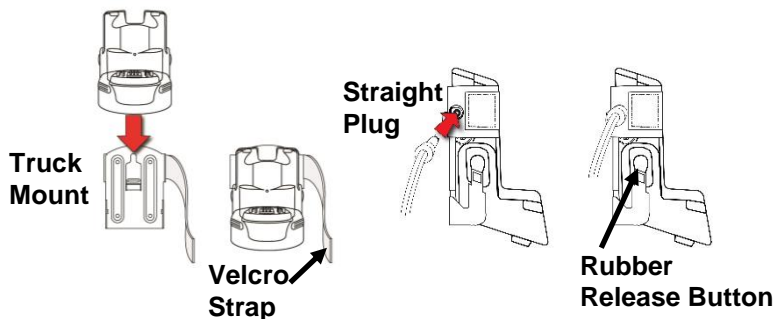

Angle-Plug Configuration

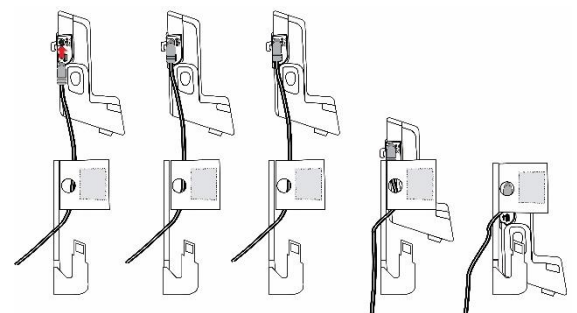

Place the MultiRAE into the cradle (make sure the bottom of the instrument and the alignment pins on the cradle mate properly) and press down until it is locked in place. Then wrap the Velcro strap around the MultiRAE and fasten its end to the mating Velcro on the side of the Truck Mount.

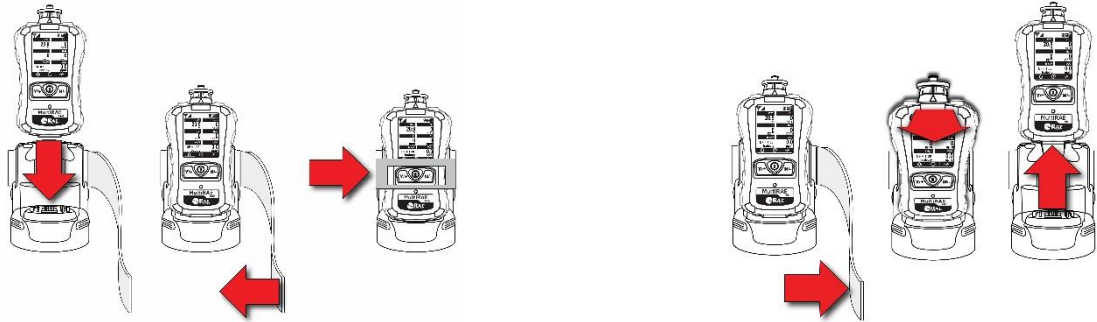

To secure: Press the MultiRAE into the cradle and fasten the Velcro strip.

To remove: Unfasten the Velcro strip, tilt the MultiRAE forward, and lift it out

Plug the other end of the charger into a power source. When power is applied and the MultiRAE's battery is charging, the LEDs on the left and right sides of the front of the cradle glow red. The LEDs glow green when the battery is fully charged.

6.7 Charging With The AutoRAE 2

A MultiRAE's battery can be charged by placing the monitor in an AutoRAE 2 Cradle. Details are covered in the AutoRAE 2 User's Guide.

Note: If the instrument has a PID lamp, auto-cleaning occurs. Refer to the information on page 32 for further details.

6.8 Replacing A Battery

The MultiRAE battery packs are plug-and-play, and can be replaced on the go without tools. To replace the MultiRAE battery:

1. Remove the battery from the instrument by sliding the tab and tilting out the adapter.

Note: The belt clip and rubber boot are removed in the illustration for clarity. They can be left on while replacing a battery.

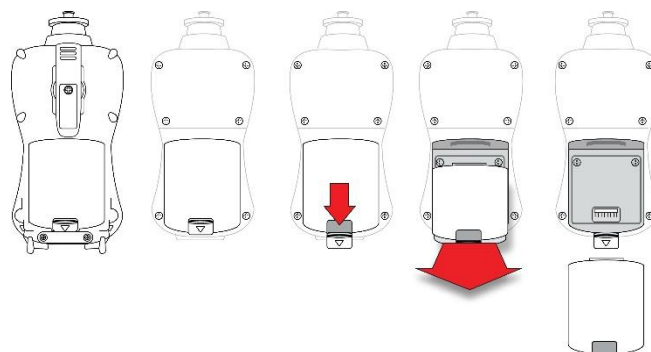

2. Tilt a fully charged battery (or alkaline battery adapter) into the battery compartment and place it in the instrument.
3. Slide the tab back into place to secure the battery.

6.9 Charging Batteries With A MultiRAE Battery Charger

The MultiRAE Battery Charger is designed to charge MultiRAE-family batteries when they are not installed in an instrument. If you are using a single MultiRAE Battery Charger, you only need the 0.5A power supply (P/N: 500-0036-100 or 500-0036-101), which comes with a universal power cord. The One-To-Five Power Cable and Holder For External Battery Charger are only necessary if you have multiple MultiRAE Battery Chargers.

6.9.1 Assembly

1. Assemble multiple External Battery Chargers on a Holder For External Battery Charger as shown:

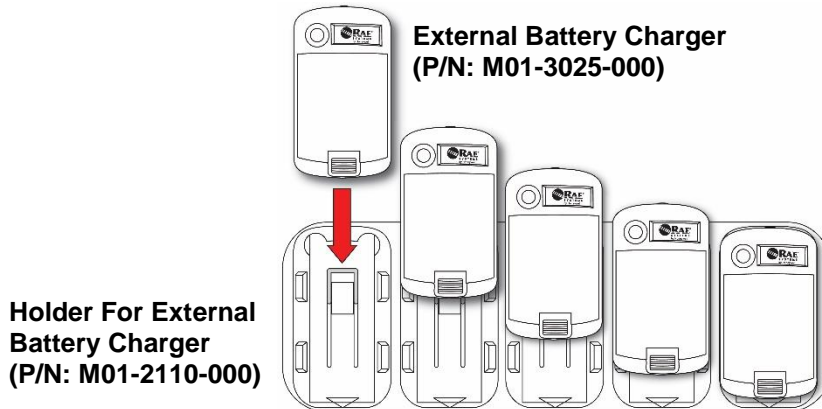

2. Connect the power cables and the power supply:

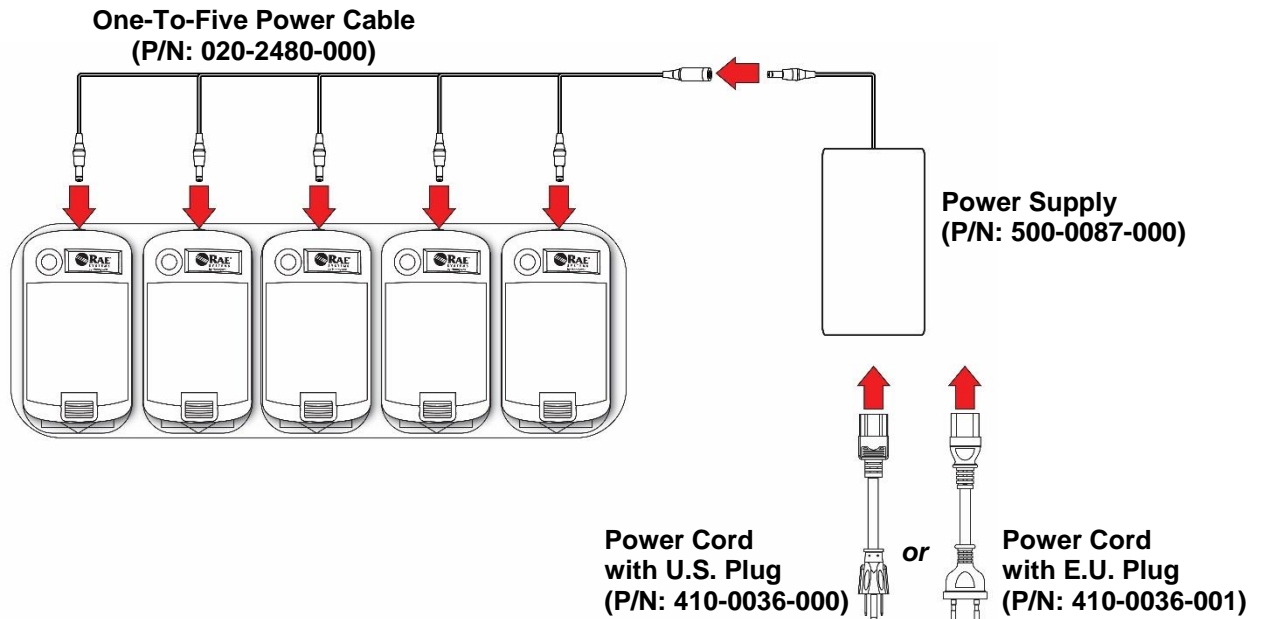

3. Plug the AC power cord into an AC power outlet.

6.9.2 Charging

IMPORTANT! Follow all instructions here before operating the MultiRAE Battery Charger. Do not try to charge alkaline batteries. Do not charge batteries in a hazardous area. Charge batteries where the temperature is between 0° and 45° C (32° and 113° F).

1. Tilt the battery into the MultiRAE Battery Charger, making sure to align it properly. Charging begins immediately.

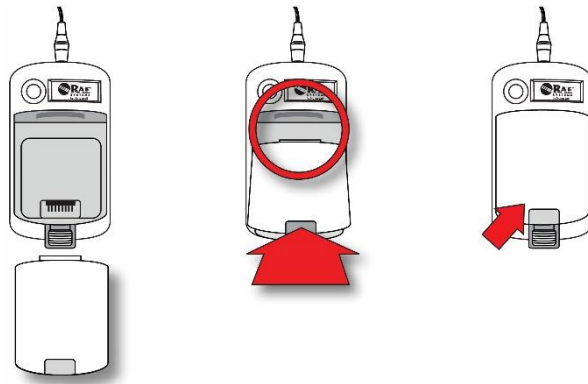



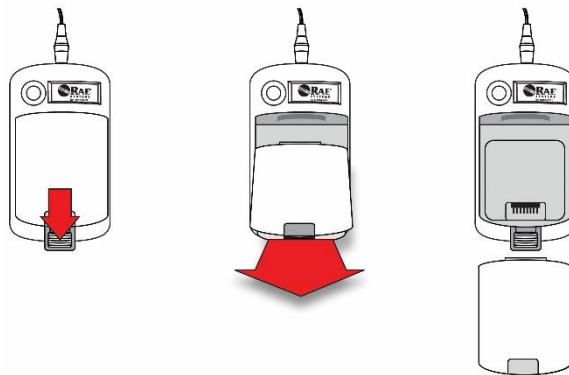

While a battery is charging, the LED on the charger glows red. When the battery is fully charged, the LED glows green.

2. Once the battery is charged, remove it from the MultiRAE Battery Charger.



6.10 Battery States

The battery icon on the display shows how much charge is in the battery and alerts you to any charging problems.

				
Full charge	2/3 charge	1/3 charge	Low charge	Battery alert

When the battery's charge falls below a preset voltage, the instrument warns you by beeping once and flashing once every minute, and the "empty battery" icon blinks on and off once per second. The instrument automatically powers down within 10 minutes, after which you will need to either recharge the battery, or replace it with a fresh one with a full charge.



6.11 Alkaline Battery Pack

An alkaline battery adapter is supplied with each instrument. The adapter (part number M01-3052-000 or M01-3054-000) is installed and removed just like the rechargeable battery. It accepts four AA alkaline batteries (use only Duracell MN1500) and provides approximately 8 hours of normal operation.

Note: The vibration alarm is disabled whenever the alkaline adapter is used.

To replace the alkaline adapter's batteries:

1. Remove the hex-socket screw at the end of the adapter.
2. Lift the cover off the battery compartment.
3. Insert four fresh AA batteries as indicated by the polarity (+/-) markings.
4. Replace the cover and replace the hex screw.

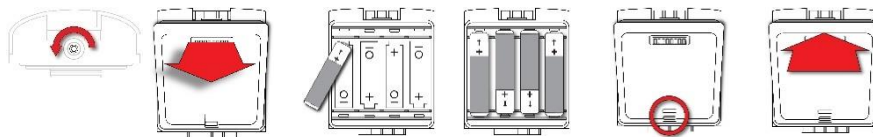

IMPORTANT!

Alkaline batteries cannot be recharged. The instrument's internal circuit detects alkaline battery pack and will not allow recharging. If you try to charge alkaline batteries installed in the instrument, the Charging Cradle or Travel Charger's charging LED does not glow, indicating that it will not charge them.

The alkaline battery adapter accepts four AA alkaline batteries (use only Duracell MN1500). Do not mix old and new batteries or batteries from different manufacturers.

Note: When replacing alkaline batteries, properly dispose of old ones.

7 Turning The MultiRAE On And Off

7.1 Turning The MultiRAE On

With the instrument turned off, press and hold the [MODE] key until the beep sounds and the display and LED alarm lights turn on, and then release.

A RAE Systems logo (or a company name) should appear first. This is followed by a progression of screens that tell you the MultiRAE's current settings:

- Product name and model number, air flow type, and serial number
- Application firmware version, build date, and build time
- Sensor firmware, build date, build time
- Installed sensors (including serial number/production/expiration/calibration date and alarm limit settings)
- Current date, time, temperature, and relative humidity
- User mode and operation mode
- Battery type, voltage, shutoff voltage
- Alarm mode and alarm settings
- Datalog period (if it is activated) and interval
- Policy Enforcement settings (whether calibration and/or bump testing are enforced)

Note: To speed up the startup time, the number of screens shown on startup can be reduced by enabling the Fast Startup option under Programming/Monitor.

Then the MultiRAE's main reading screen appears. It may take a few minutes for sensors to show a reading, so if any have not warmed up by the time the main screen is shown, you will see "--" instead of a numerical value until the sensor provides data (typically less than 2 minutes). Then it displays instantaneous readings similar to the following screen (depending on the sensors installed) and is ready for use.

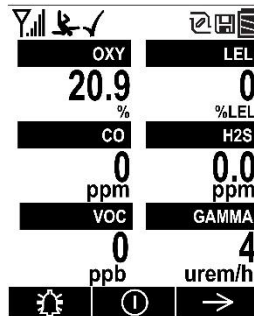

Note: If the battery is completely empty, then the display briefly shows the message “Battery Fully Discharged,” and the MultiRAE shuts off. You should charge the battery or replace it with a fully charged battery before turning it on again.

7.2 Turning The MultiRAE Off

Press and hold [MODE]. A 5-second countdown to shutoff begins. You must hold your finger on the key for the entire shutoff process until the MultiRAE is powered off.

7.3 Testing Alarm Indicators

Under normal-operation mode and non-alarm conditions, the buzzer, vibration alarm, LED, and backlight can be tested at any time by pressing [Y/+] once.

IMPORTANT!

If any of the alarms does not respond to this test, check the Alarm Settings in Programming Mode. It is possible that any or all of the alarms have been turned off. If all of the alarms are turned on, but one or more of them (buzzer, LED lights, or vibration alarm) does not respond to this test, do not use the instrument. Contact your RAE Systems distributor for technical support.

7.4 Glance Mode

Glance Mode allows you to get vital information without turning the MultiRAE on. You can check information such as the instrument's model number, installed sensor types, etc., which may help when taking inventory of instruments and their sensors or when working with service or support personnel. Glance Mode can be enabled/disabled via ProRAE Studio II.

7.4.1 Enter Glance Mode

Note: The instrument must be configured so that Glance Mode is turned on (the default mode is “On”). This can be done in ProRAE Studio II.

With the MultiRAE turned off, press and hold [MODE] and [N/-] together to enter Glance Mode. The feature is latched, meaning that it runs even after you release the keys. If you see the message “GLANCE DISABLED,” you must configure the instrument to use Glance Mode.

In ProRAE Studio II, Glance Mode can be enabled or disabled by checking or unchecking the box labeled “Enable Glance Mode.”

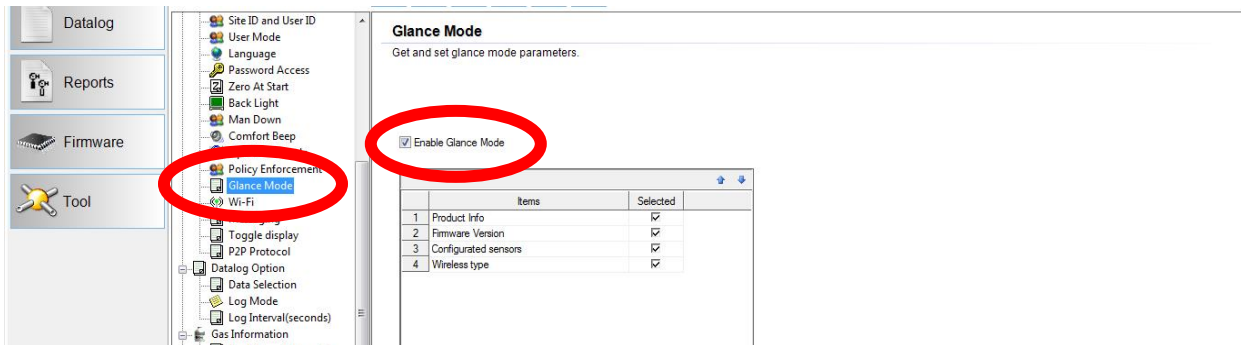

7.4.2 Screens

After releasing [MODE] and [N/-], the other screens can be displayed by pressing the [N/-] Key. **Note:** Some screens continue on secondary screens. Where you see “More,” press [Y/+] to see these.

7.4.3 Exit Glance Mode

MultiRAE exits Glance Mode and turns off when you press the [MODE] key. In addition, if you do not press either key in 60 seconds, the MicroRAE automatically exits Glance Mode.

7.5 Pump Status

IMPORTANT!

During operation, make sure the probe inlet and the gas outlet are free of obstructions. Obstructions can cause premature wear on the pump, false readings, or pump stalling. During normal operation, the pump icon alternately shows inflow and outflow as shown here:



If there is a pump failure or obstruction that disrupts the pump, the alarm sounds and you see this icon blinking on and off:



Once the obstruction is removed, you can try to restart the pump by pressing the [Y/+]. If the pump does not restart, and the pump stall alarm continues, consult the Troubleshooting section of this guide or contact RAE Systems Technical Support.

It is advisable to perform a pump stall test periodically, to make sure the pump is working properly and there are no leaks in the system. To perform a pump stall test, simply block the gas inlet with your finger. To pass the test, the instrument should go into a pump alarm. Press [Y/+] to disable the alarm and return to normal operation.

Note: Pump Status is not indicated on diffusion MultiRAEs.

Note: For all MultiRAE instruments with a PID (in Search or Hygiene mode), if the pump is in alarm for more than five minutes, the PID lamp automatically turns off. The display reading shows “- - -” and there is a “Lamp” alarm. Click [Y/+] to restart the pump. If there is no longer a pump alarm, then the PID lamp will require a 2-minute warm-up to stabilize. During this time, the PID’s reading shows “- - -”. Once the PID lamp is warmed up, the display shows the actual value.

7.6 Calibration Status

The instrument displays this icon next to the sensor that requires calibration:



Calibration is required (and indicated by this icon) if:

- The lamp type has been changed.
- The sensor module has been replaced with one whose calibration is overdue.
- The defined period of time between calibrations has been exceeded.
- If you have changed the calibration gas type without recalibrating the instrument.
- The sensor has failed a previous calibration.

7.7 Bump Status

The instrument displays this icon next to the sensor that requires bump test:



A bump test is required (and indicated by this icon) if:

- The defined period of time between bump tests has been exceeded (bump test overdue).
- The sensor has failed a previous bump test.
- The sensor(s) should be challenged on a periodic basis.

7.8 Toggle Display: Alternating Between Correction Factor And Reading

A MultiRAE's display can alternate between showing readings for LEL and VOC and their respective correction factors. To enable this feature, you must do the following:

1. Use the USB cable to connect the MultiRAE to a PC running ProRAE Studio II.
2. Step through the screens on the MultiRAE using the [N/-] button until you see the screen that says, "Enter Communications Mode."
3. Press [Y/+].
4. With "PC" selected, press [Y/+].
5. Start ProRAE Studio II.
6. Log in with your password.
7. Click "Setup."
8. Once the setup is shown in the right pane, click "Toggle display."
9. Select "Enable."
10. Click on the button at the top labeled "Upload all settings to the instrument."
11. When uploading is complete, exit ProRAE Studio II and disconnect the USB cable.
12. Press [Y/+] on the MultiRAE.

Note: If you want to disable this feature and only see the reading without the correction factors, follow the same procedure, but instead of selecting "Enable," select "Disable."

7.9 Enabling Benzene Sep-Tube Cartridge Tutorial (MultiRAE Benzene)

The MultiRAE Benzene's display can show an animated tutorial to guide using a Benzene Sep-Tube Cartridge. To enable this feature, you must do the following:

1. Use the USB cable to connect the MultiRAE Benzene to a PC running ProRAE Studio II.
2. Step through the screens on the MultiRAE Benzene using the [N/-] button until you see the screen that says, "Enter Communications Mode."
3. Press [Y/+].
4. With "PC" selected, press [Y/+].
5. Start ProRAE Studio II.
6. Log in with your password.
7. Click "Setup."
8. Once the setup is shown in the right pane, click "Tutorial Status."
9. Select "Enable."
10. Click on the button at the top labeled "Upload all settings to the instrument."
11. When uploading is complete, exit ProRAE Studio II and disconnect the USB cable.
12. Press [Y/+] on the MultiRAE Benzene.

Note: To disable this feature, follow the same procedure, but instead of selecting "Enable," select "Disable."

8 Modes Of Operation

The MultiRAE has two operation modes and two user modes.

8.1 Hygiene Operation Mode

Hygiene Mode provides continuous monitoring.

8.2 Search Operation Mode

Search Mode provides monitoring only when monitoring is initiated. This allows specific samples to be taken at different times, rather than continuously.

8.3 Benzene-Specific Mode (MultiRAE Benzene Only)

The MultiRAE Benzene can perform snapshot compound-specific (benzene) measurement in addition to general VOC measurement. This requires using a RAE-Sep Tube Cartridge (P/N: M01-3222-000, available in packs of 6: P/N M01-0312-000) and having the MultiRAE Benzene in Benzene Mode.

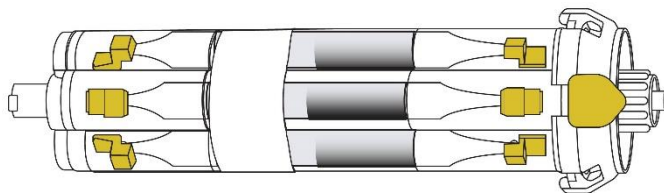

WARNING!

The RAE-SEP Tube Cartridge is designed to provide six one-time specific measurements of benzene. This cartridge has unique properties and performance features not found in other monitors. It has been designed to provide accurate, benzene-only measurement and has only been evaluated and tested on the MultiRAE Benzene monitor.

Failure to use the MultiRAE Benzene monitor with the RAE-Sep Tube Cartridge will result in inaccurate detection or measurement, which may include the failure to detect benzene and possible serious injury or death.

IMPORTANT!

The RAE-Sep Tube Cartridge is warranted by RAE Systems by Honeywell only for use with the MultiRAE Benzene monitor. Any other use will void the product warranty. In addition, RAE Systems by Honeywell specifically disclaims liability for all loss or damage arising out of any use of the RAE-Sep Tube Cartridge that violates the warnings and instructions in this manual.

8.3.1 Separation Tube Cartridge Installation

Before using the MultiRAE Benzene for benzene-specific measurement, you must attach a RAE-Sep Tube Cartridge to the MultiRAE Benzene. Follow this procedure:

1. Remove the dust filter from the MultiRAE Benzene (if one is currently attached).
2. Align a new RAE-Sep Tube Cartridge with the MultiRAE Benzene's inlet.
3. Screw on the RAE-Sep Tube Cartridge until it is seated snugly in place.
4. The "B" switch of the RAE-Sep Tube Cartridge should be aligned with the triangle on the inlet.

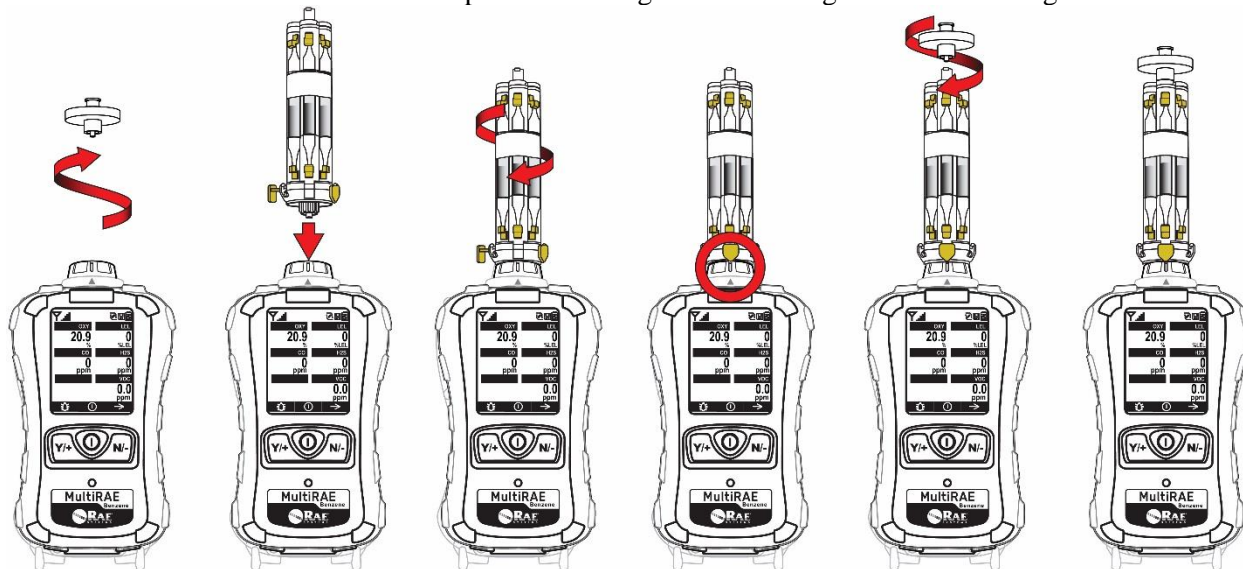

IMPORTANT!

Do not overtighten any portion of the sampling assembly.

Note: When the MultiRAE Benzene is used only for VOC monitoring, there is no need to use a RAE-Sep Tube Cartridge. Make sure the cartridge is set for TVOC operation (the letter "T" should be visible).



Always rotate the RAE-Sep Tube Cartridge clockwise. Turning it counterclockwise loosens it from the inlet. Rotate the cartridge so that a new (unused) tube is aligned with the "B" marker.

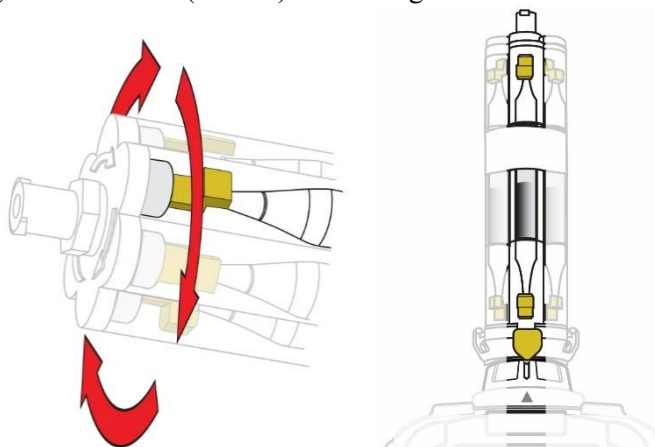

Note the yellow tabs at both ends of each tube. These are for breaking the ends of the tubes to open them.

IMPORTANT!

Break the ends of *only one tube at a time*.

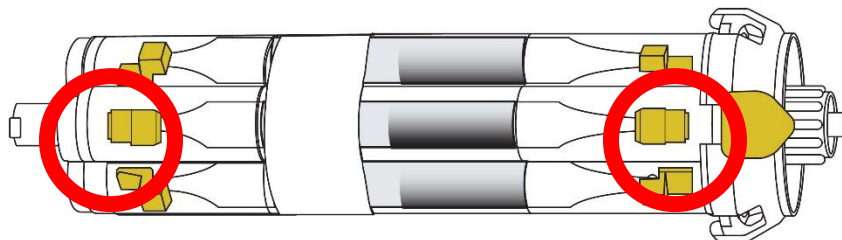

Press the tab hard to break off the end of the tube to be used. (The broken glass is held inside the cartridge.)

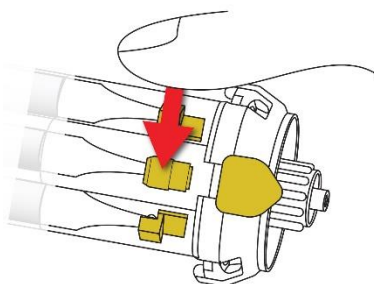

Press the tab at the other end to break open the other end of the tube.

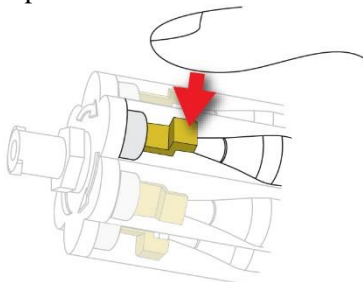

IMPORTANT!

Once a tube's ends are broken off, the material inside is exposed. Therefore, use the tube for sampling as soon as possible.

Before performing a benzene measurement, check that the tab labeled "B" is pulled all the way out.

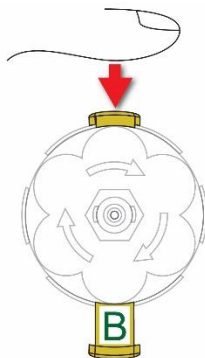

Before starting another benzene sample session, turn the RAE-Sep Tube cartridge to the next unused tube.

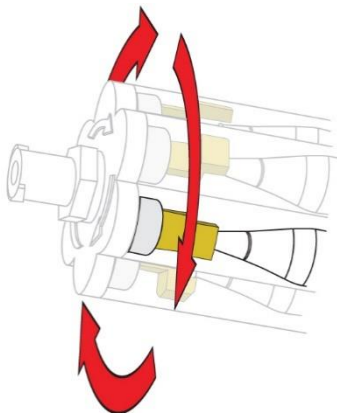

IMPORTANT!

If the MultiRAE Benzene goes into pump stall (the pump stops, the LEDs flash, and the “Pump Stall” icon appears in the display), check the alignment of the tube and the RAE-Sep Tube Cartridge setting. Also check that the both ends of the tube have been cracked off. If one has not been cracked off, the sample will not be able to pass through, causing the pump to stall.

Note: After all six RAE-Sep Tubes in the cartridge have been used, remove the cartridge and dispose of it in a safe manner.

8.3.2 Measurement

To perform a benzene-specific measurement, follow this order:

1. Attach the RAE-Sep Tube Cartridge to the MultiRAE Benzene. Make sure it is set for TVOC measurement (the “T” is showing).
2. Turn on the instrument. Allow it to go through its startup until the main reading screen is shown.
3. Press [N/-] to advance to this screen:

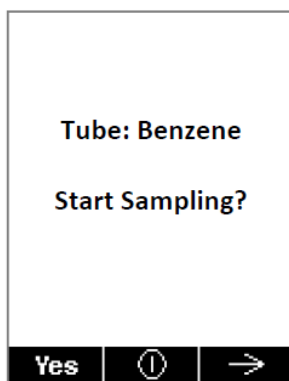

Note: If the MultiRAE Benzene is in this mode for more than five minutes, it automatically returns to TVOC Mode.

4. Press [Y/+]. You see this screen:

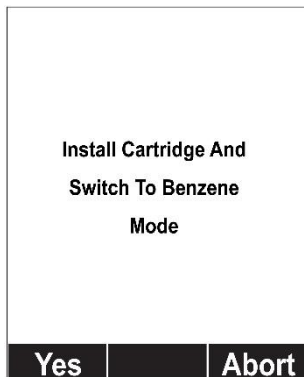

Make sure the cartridge is installed tightly, and the selector shows “B”:

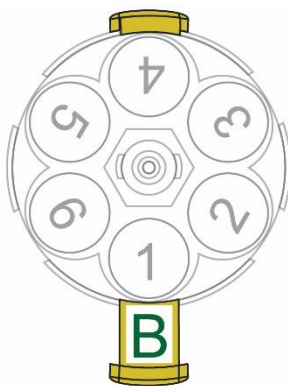

5. Press [Y/+]. You now see this prompt:

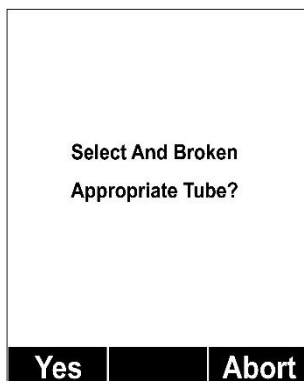

Check that the ends of the selected tube are broken.

6. Press [Y/+]. Measurement starts and the instrument shows a countdown (time of measurement is automatically adjusted to gas sample temperature). Countdown time is automatically adjusted, depending on temperature.

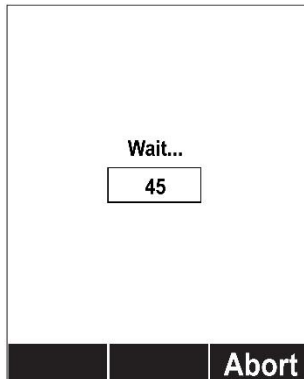

Once the countdown is completed, the display shows a benzene-specific snapshot result (and triggers an alarm if appropriate).

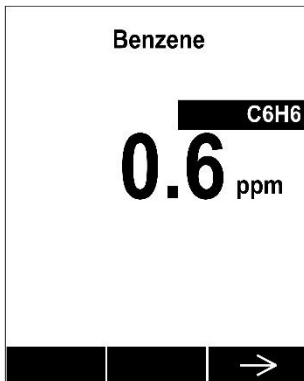

7. Press [N/-] to exit. You see this screen again:

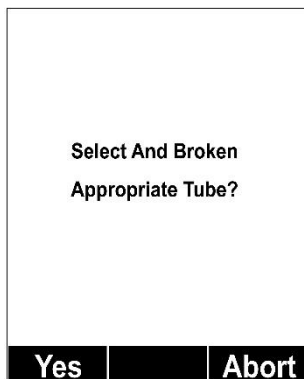

If you want to perform another snapshot benzene-specific measurement, press [Y/+] and continue, using the same procedure as outlined above. Otherwise, press [N/-] to abort. You see this screen:

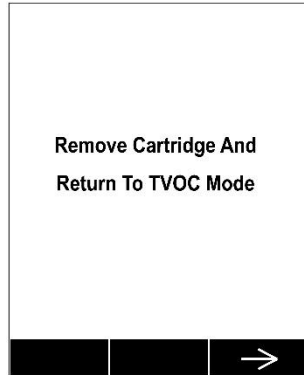

8. If you are done performing benzene measurements or if you want to use the MultiRAE Benzene for TVOC operation, either remove the RAE-Sep Tube Cartridge or press the button so that the “B” is hidden and the “T” side is fully exposed (all the way out):

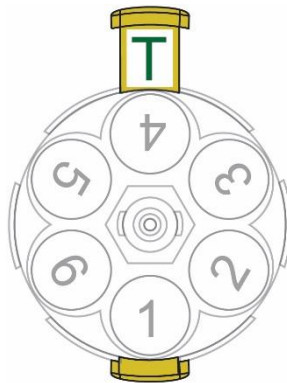

9. Press [N/-] to advance to the main reading screen.

IMPORTANT!

Do not overtighten any portion of the sampling assembly.

Note: When the MultiRAE Benzene is used only for TVOC (total VOC) monitoring, there is no need to use a RAE-Sep Tube Cartridge. If the cartridge is left on during VOC monitoring, make sure it is set for TVOC measurement (the “T” is showing).

8.4 Basic User Mode

In Basic User Mode, some restrictions are applied, including password protection that guards against entering Programming Mode by unauthorized personnel.

8.5 Advanced User Mode

In Advanced User Mode, there are no access restrictions (you do not need a password), and MultiRAE provides the indications and data you need most for typical monitoring applications.

9 Programming

The menu in Programming Mode is to adjust settings, calibrate sensors, and initiate communication with a computer. It has the following submenus:

- Calibration
- Measurement
- Alarms
- Datalog
- Wireless
- Monitor

9.1 Enter Programming In Advanced Mode

1. To enter Programming Mode, press and hold [MODE] and [N/-] until you see the Calibration screen. No password is necessary in Advanced Mode.
2. Press [N/-] to step through the programming screens.

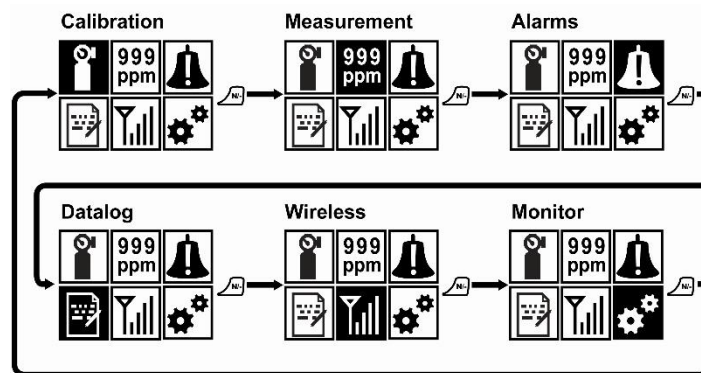

To enter a menu and view or edit parameters in its submenus, press [Y/+].

9.2 Enter Programming In Basic Mode

1. To enter Programming Mode, press and hold [MODE] and [N/-] until you see the Password screen.

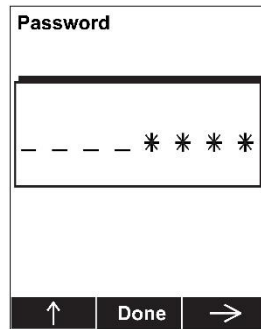

2. Input the 4-digit password:

- Increase the number from 0 through 9 by pressing [Y/+].
- Step from digit to digit using [N/-].
- Press [MODE] when you are done.

If you make a mistake, you can cycle through the digits by pressing [N/-] and then using [Y/+] to change the number in each position.

Note: The default password is 0000.

Note: The password screen only appears when you enter the Programming Mode the first time after turning the instrument on in Basic Mode. If you have input the correct password, you do not have to input it again to enter Programming Mode until you turn the instrument off and on again.



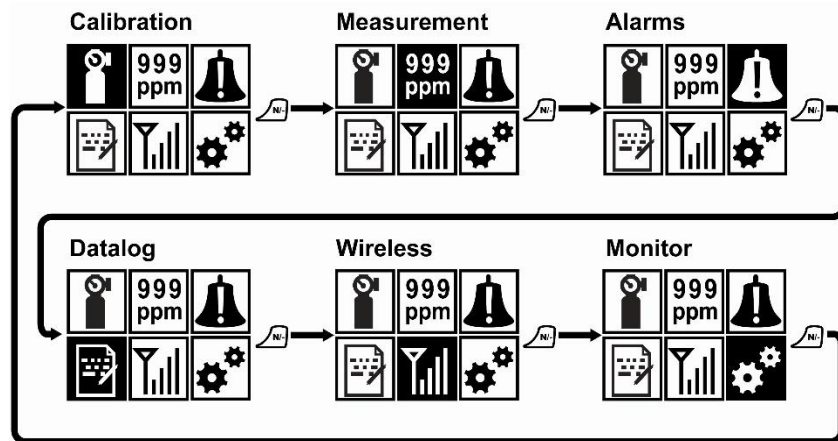



Once you enter Programming Mode, the Calibration menu is highlighted. Press [N/-] to step through the programming screens.



To enter a menu and view or edit parameters in its submenus, press [Y/+].

9.3 Menus And Submenus

In Programming Mode, menus and submenus are organized as shown here:

					
Calibration	Measurement	Alarms	Datalog	Wireless*	Monitor
Fresh Air	Sensor On/Off	Alarm Limits	Clear Datalog	Radio ON/OFF	LCD Contrast
Multi Sensor Span	Change Meas. Gas	Alarm Mode	Datalog Interval	Roaming	Pump Speed**
Single Sensor Zero	Measurement Units	Alarm Settings	Sensor Selection	PAN ID	Zero At Start
Single Sensor Span		Comfort Beep	Data Selection	Channel	Fast Startup
Multi Sensor Bump		Man Down Alarm	Datalog Type	Join Network	Temperature Units
Single Sensor Bump			Memory Full Action	Interval	Language
Cal. Reference				Off Network Alarm	Site ID
Change Cal. Gas				Factory Reset	User ID
Multi Cal. Select					Date Format
Change Span Value					Date
Change Span2 Value***					Time Format
					Time
					User Mode
					Backlight
					LCD Flip

* This menu is available on wirelessly equipped instruments only. The menu is different for MultiRAE Lites equipped with optional Wi-Fi. Refer to page 78 for details.

** Pump-equipped version only.

*** This menu item is shown only if a 3-point calibration is enabled. Change Span2 Value menu item is only shown if a 3-point calibration is enabled on the instrument. Three-point calibration is disabled by default, but can be enabled on MultiRAE and MultiRAE Pro instruments with 10.6eV PID sensors, including high-range ppm and ppb PID sensors. The MultiRAE Lite PID sensors only support 2-point calibration.

9.3.1 Editing And Selecting Parameters And Sensors

There are a few basic ways to edit parameters, select sensors, and perform other activities in the MultiRAE. The actions performed by pressing keys always match 1-to-1 with the boxes along the bottom of the display and the three keys. Some parameters are edited by scrolling and selecting individual items (black bars behind white text act as highlighters). Some include a choice via “radio buttons,” where only one item in a list can be selected, while other menus use

boxes for you to “check” with an “X,” and these allow for multiple items in a list to be selected. In all cases of editing, you can save or undo your choice.

9.3.2 Calibration

Use this menu to perform a bump test or zero or span calibration for one or more sensors, and change the gas concentration value used in bump tests and span calibration, as well as choose which sensors will be calibrated at the same time.

9.3.3 Bias & Equilibration For Liquid O₂ And Other Biased Sensors

Some electrochemical sensors (NO, NH₃, Liquid O₂) require a bias voltage to detect the gas, while most do not. Unbiased sensors may be shipped with a shorting pin across the electrodes to avoid an accidental bias. The pin should be removed before installation. Biased sensors require an equilibration time (also known as warm-up time) of at least 6 hours, and sometimes more, after installation for the baseline to become stable enough to calibrate the sensor. Unbiased sensors require at least 10 minutes to stabilize. Once installed, any sensor bias stays on, even when the meter is off. Therefore, even biased sensors are ready for immediate use when the instrument is turned on again, and the equilibration time is needed only when first installed or if the battery becomes completely drained. The SensorRAE 4R+ can be used to maintain bias on NO and other biased sensors, so long equilibration times can be avoided when installing such sensors into a multi-gas instrument.

CAUTION

If an instrument is calibrated directly after sensor installation (no equilibration time, no use of SensorRAE 4R+), readings will be seen to decrease until the sensor’s bias is stable. Also, this may trigger a low alarm, even if calibration passes.

Refer to RAE Systems Technical Note TN-114 for a list of biased sensors.

9.3.3.1 Fresh Air

This procedure determines the zero point of the sensor calibration curve for all the sensors that require a zero calibration. For the oxygen sensor, Fresh Air calibration sets the point equal to the concentration of oxygen in ambient air (approximately 20.9% volume).

Note: Fresh air calibration is performed on all enabled gas sensors at the same time.

To perform Fresh Air calibration on multiple sensors:

1. If using dry air, install the calibration adapter and connect it to a source of dry air. Otherwise do not use calibration adapter to perform fresh air calibration.
2. At the Calibration Menu, select “Fresh Air.” Press [Y/+] once to enter the fresh air calibration sub-menu.



3. Start the flow of dry air, if used.
4. Press [Y/+] to start fresh air calibration.

- A countdown screen appears. You can abort the calibration at any time during the countdown by pressing [N/-].

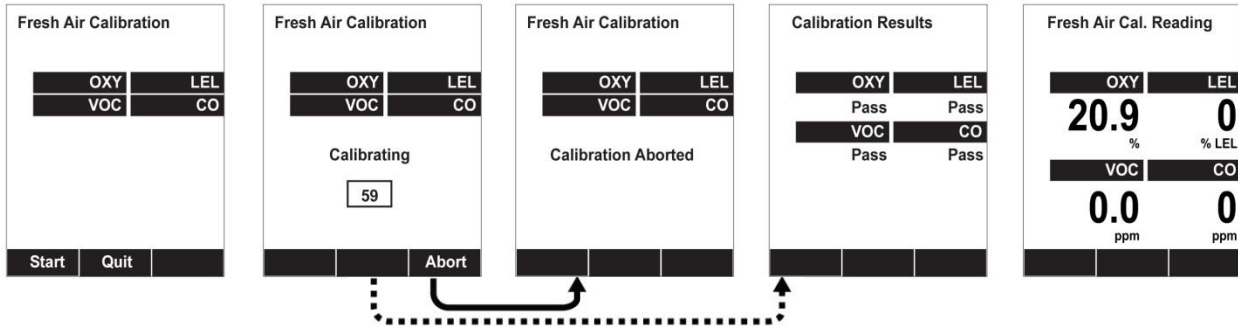

Note: Dotted line indicates automatic progression.

- If the calibration is not aborted, the display shows the sensor names and tells you whether the fresh air calibration passed or failed, followed by the sensors' fresh air readings.

9.3.3.2 Multi Sensor Span

Depending on the configuration of your MultiRAE and span gas you have, you can perform a span calibration simultaneously on multiple sensors. You can define which sensors are calibrated together using the Multi Cal Select menu described in section 9.3.3.10.

In case all sensors in the instrument cannot be calibrated with the same gas, the MultiRAE will intelligently split the span calibration process into several steps and will provide menu prompts accordingly.

1. At the Calibration Menu, select “Multi Sensor Span.”
2. Install the calibration adapter and connect it to a source of calibration gas.
3. Start the flow of calibration gas.
4. Press [Y/+] to start calibrating or wait for calibration to start automatically.
5. A countdown screen is shown. You can abort the calibration at any time during the countdown by pressing [N/-].

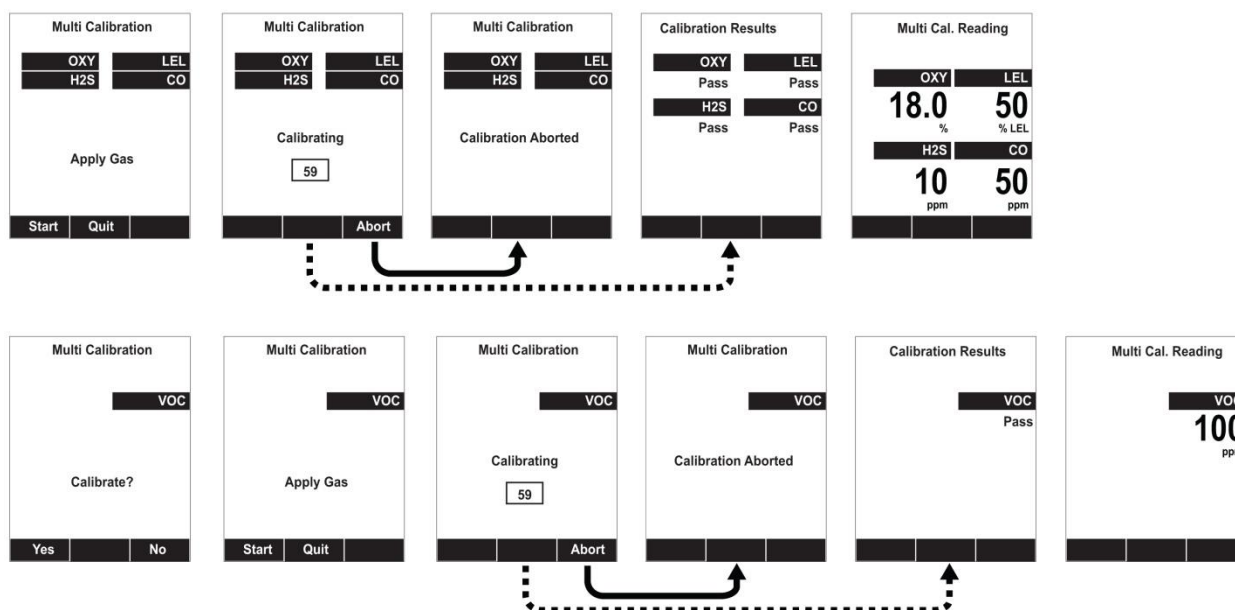

Note: Dotted line indicates automatic progression.

6. If the calibration is not aborted, the display shows the sensor names and tells you whether the calibration passed or failed, followed by the sensor readings.

9.3.3.3 Single Sensor Zero

This allows you to perform zero (fresh air) calibration on individual sensors. Even though most toxic gas sensors can be zeroed in fresh air, sensors such as the CO₂ and parts-per-billion PID sensor for volatile organic compounds (VOCs) should not be zeroed in fresh air. Both CO₂ gas and VOCs are normally present in ambient air, so zeroing these sensors in ambient air will not allow for a true zero to be set for such sensors. The CO₂ sensor should be zeroed in 99.9% nitrogen, and the parts-per-billion PID sensor with ambient air using a charcoal filter or a VOC zeroing tube.

1. If you are using a charcoal filter, connect it to the instrument.
2. If you are using dry air, install the calibration adapter and connect it to a source of dry air.

3. At the Calibration Menu, select “Single Sensor Zero.” Press [Y/+] once to enter the zero calibration sub-menu.
4. Start the flow of dry air, if used.
5. Press [Y/+] to start zero calibration.
6. A countdown screen appears. You can abort the calibration at any time during the countdown by pressing [N/-].

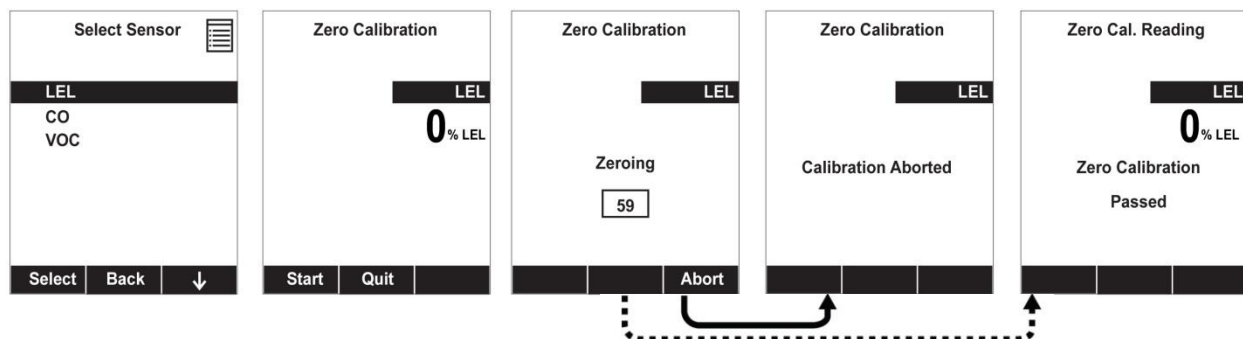

Note: Dotted line indicates automatic progression.

7. If the calibration is not aborted, the display shows the sensor names and tells you whether the zero calibration passed or failed, followed by the sensors’ zero calibration readings.

9.3.3.4 Single Sensor Span

Instead of performing a span calibration on multiple sensors simultaneously, you can select a single sensor and perform a span calibration.

Note: If a calibration icon (bottle with bottom portion filled in) is shown next to any of the sensors, it means that the sensor is due for a full calibration.

To perform span calibration of an individual sensor, follow these steps:

1. At the Calibration Menu, select “Single Sensor Span.”
2. Select a sensor to calibrate from the list.
3. Install the calibration adapter and connect it to a source of calibration gas.
4. Verify that the displayed calibration value meets the concentration specified on the gas cylinder.
5. Start the flow of calibration gas.



6. Press [Y/+] to start calibrating or wait for calibration to start automatically.

- A countdown screen appears. You can abort the calibration at any time during the countdown by pressing [N/-].

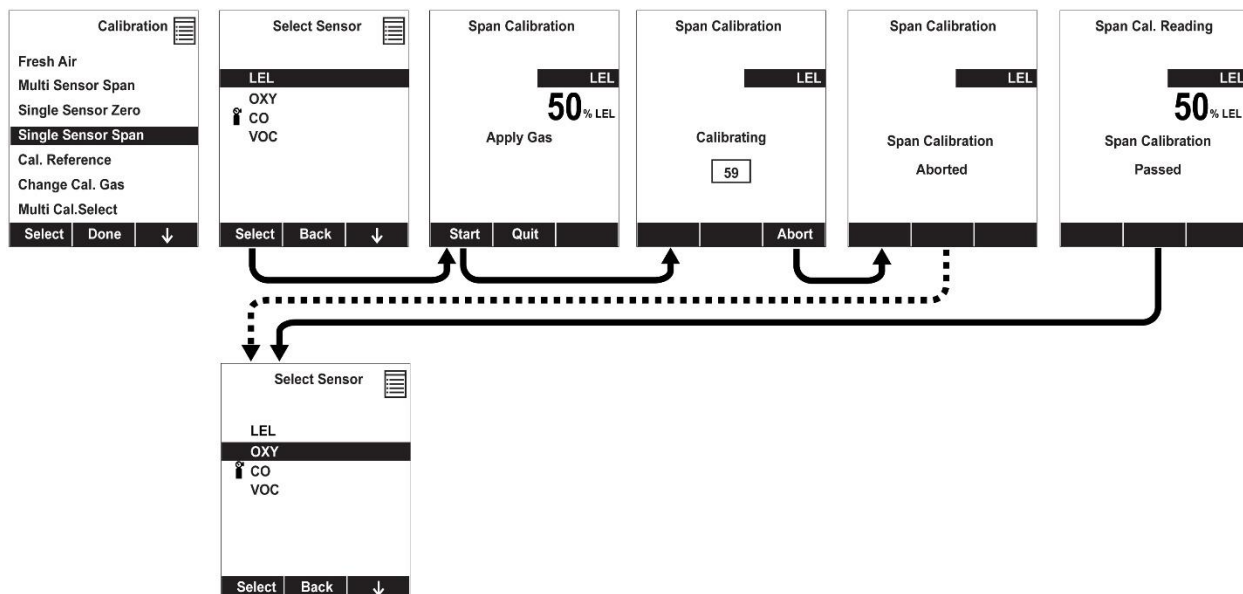

Note: Dotted line indicates automatic progression.

- If the calibration is not aborted, the display shows the sensor names and tells you whether the calibration passed or failed, followed by the sensor readings.

Note: The gamma radiation sensor comes pre-calibrated from the factory and does not require routine calibration. However, you can check it by placing a check-source on the rear of the MultiRAE equipped with a gamma sensor to check the readings. There is a raised dot on the rubber boot that marks where the sensor is located inside the instrument.

9.3.3.5 MultiRAE Benzene Calibration Process

Calibrating the MultiRAE Benzene is similar to calibrating other MultiRAEs. Calibration is performed with isobutylene and benzene. Make sure the target gas is the same as the calibration gas and that it is in the correct concentration.

IMPORTANT!

- The MultiRAE Benzene must not have a RAE-Sep Tube Cartridge installed during calibration.
- A filter must be attached to the inlet.
- The calibration adapter must be used for calibration with both gases (isobutylene and benzene).

9.3.3.6 Multi Sensor Bump

Depending on the configuration of your MultiRAE and span gas you have, you can perform a bump test simultaneously on multiple sensors. Which sensors are bump tested simultaneously is defined in the Multi Cal Select menu. Refer to section 9.3.3.10 for more information.

In case all sensors in the instrument cannot be calibrated with the same gas, the MultiRAE will intelligently split the span calibration process into several steps and will provide menu prompts accordingly.

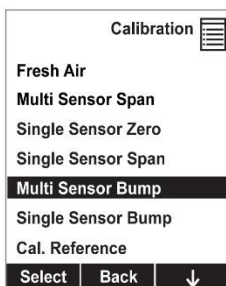

1. At the Calibration Menu, select “Multi Sensor Bump.”
2. Install the calibration adapter and connect it to a source of calibration gas.
3. Start the flow of calibration gas.
4. Press [Y/+] to start calibrating or wait for calibration to start automatically.
5. A countdown screen is shown. You can abort the calibration at any time during the countdown by pressing [N/-].

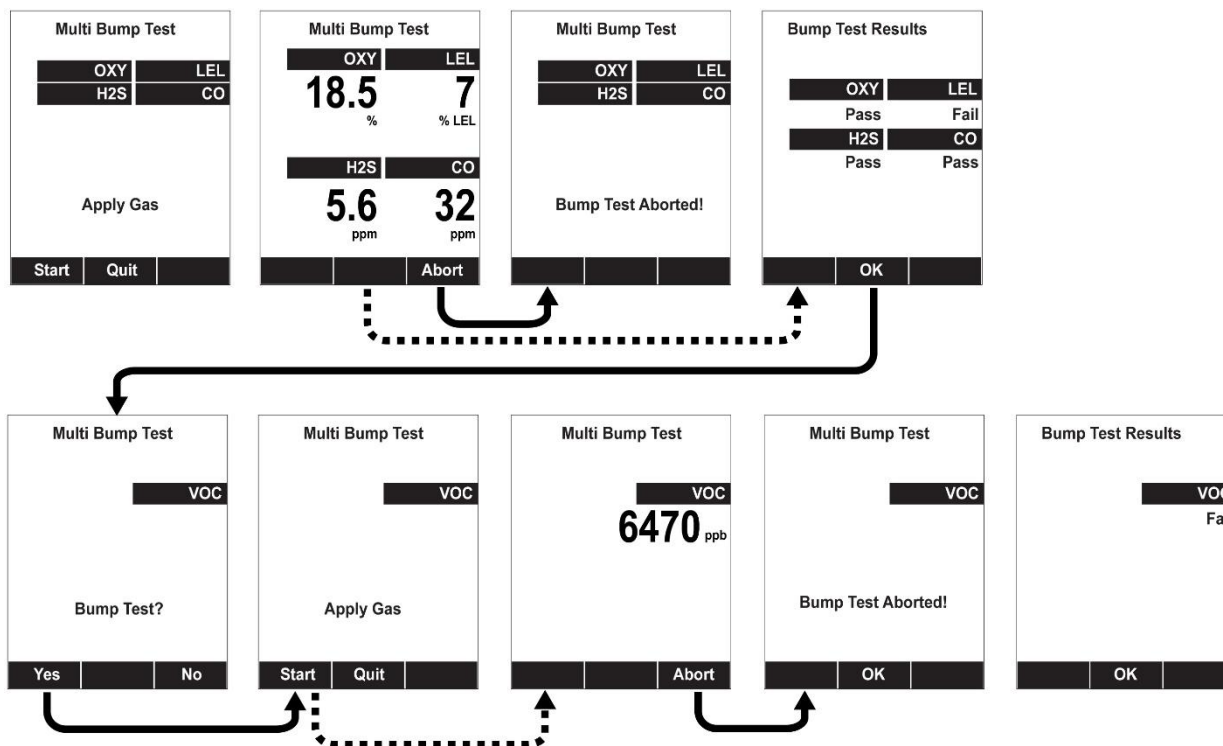

Note: Dotted line indicates automatic progression.

6. If the calibration is not aborted, the display shows the sensor names and tells you whether the calibration passed or failed, followed by the sensor readings.

7. If a sensor requires different gas (such as a PID for VOCs), you are prompted. Change the calibration gas, and when you are ready, start bump testing by pressing [Y/+].

Note: You can quit the bump calibration procedure and exit to the menu whenever you see “Quit.” Press [MODE] to quit.

9.3.3.7 Single Sensor Bump

This menu allows a bump test to be performed on an individual sensor of your choice.

Note: If a bump test icon (bottle with bottom portion not filled in) is shown next to any of the sensors, it means that the sensor is due for a bump test.



To perform a bump test on an individual sensor, follow these steps:

1. At the Calibration Menu, select “Single Sensor Bump.”
2. Scroll down the list using [N/-], and then press [Y/+] to select a sensor to calibrate.
3. Install the calibration adapter and connect it to a source of calibration gas.
4. Verify that the displayed calibration value meets the concentration specified on the gas cylinder.
5. Start the flow of calibration gas.

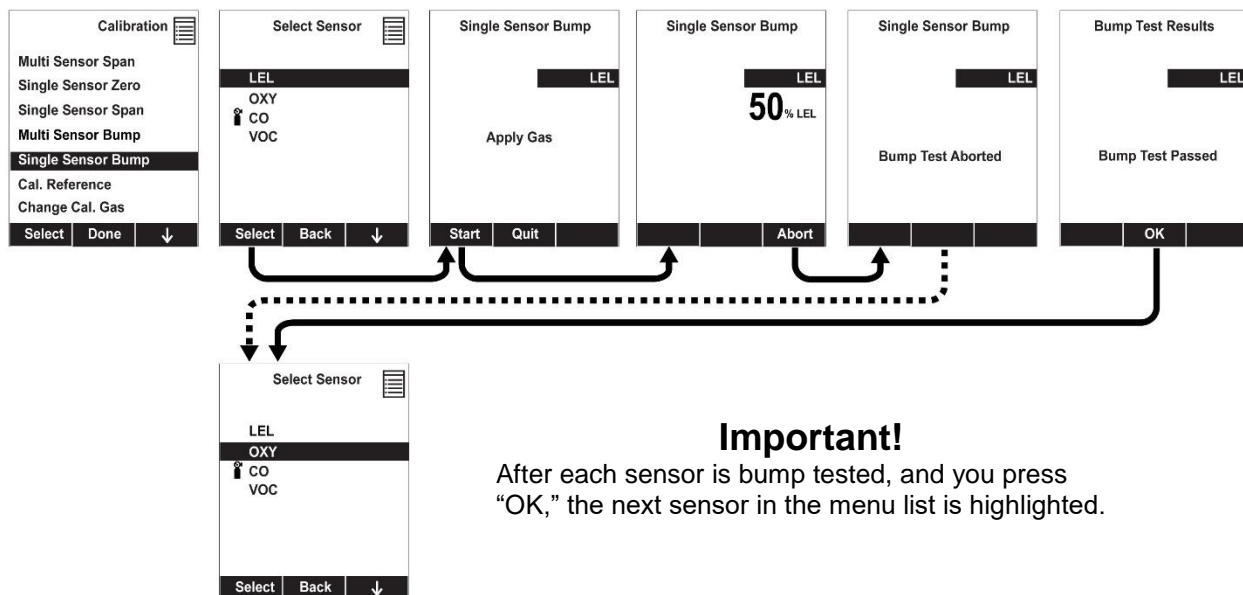

Note: Dotted line indicates automatic progression.

6. Press [Y/+] to start calibrating or wait for calibration to start automatically.
7. A countdown screen appears. You can abort the calibration at any time during the countdown by pressing [N/-].
8. If the calibration is not aborted, the display shows the sensor names and tells you whether the calibration passed or failed, followed by the sensor readings.

9.3.3.8 Cal. Reference

It is sometimes desirable to calibrate a sensor (PID for VOC, and LEL) with a specific gas for best response to a gas you are surveying. The Cal. Reference library contains calibration curves for the PID and LEL sensors for select gases. Choose the sensor, and then select from the list of reference gases.

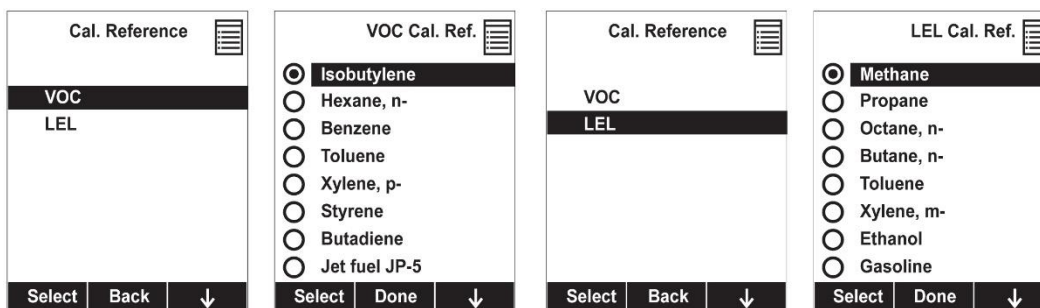

9.3.3.9 Change Cal. Gas

You can change the calibration gas for the MultiRAE's PID and LEL sensors. Select from a custom list that you create (My List), the last ten gases used, the built-in gas library for your PID lamp, and user-defined custom gases. Each gas is shown in the list for selection and the screen automatically changes to show its full name, chemical formula, molecular weight (M.W.) and correction factor (CF).

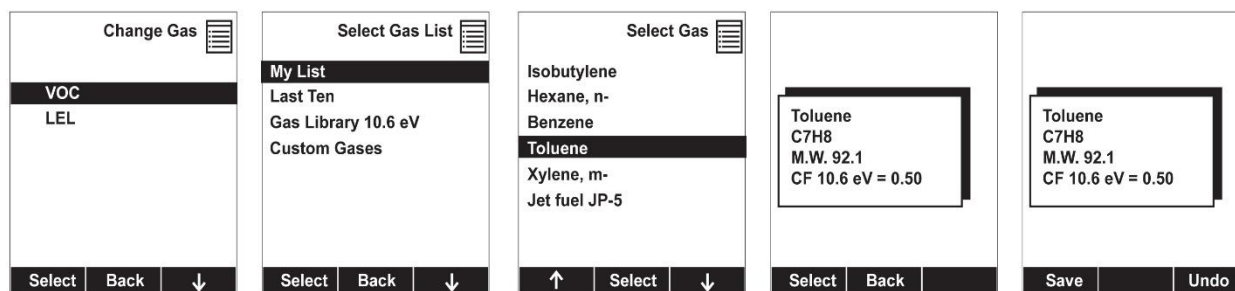

9.3.3.10 Multi Cal Select

This menu allows you to define a group of sensors to be bump tested and span calibrated together. Simultaneous testing and calibration of multiple sensors shortens the bump test and calibration processes and reduces the number of individual gas cylinders you need. For example, it may be more efficient to use a single cylinder with a four-gas mix including 50% LEL Methane, 18% O₂, 10 ppm H₂S, and 50 ppm CO, to calibrate the LEL, O₂, CO, and H₂S sensors at one time, compared to using four distinct gas cylinders and calibrate these sensors individually in sequence. In order for sensors to be calibrated together, all of them must be selected using Multi Cal. Select.

1. Scroll down the list of sensors using the [N/-] key.
2. Add or remove that gas from the list by pressing [Y/+]. An "X" in a box to the left of a sensor's name indicates it is selected.
3. Once you have made all your selections, press [MODE] for "Done."

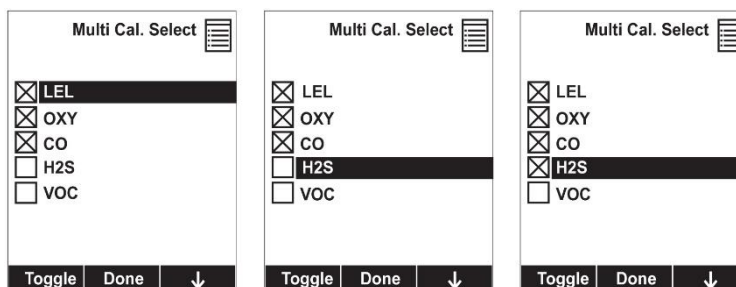

9.3.3.11 Change Span Value

You can individually set the span gas concentration for each sensor. This concentration setting will also be used for a bump test. The units of measure (ppm, %LEL, etc.) are shown on the display.

1. Scroll down the list of sensors using the [N/-] key.
2. Press [Y/+] to select it.
3. Press [N/-] to step through the digits.
4. Press [Y/+] to increase the number from 0 through 9. Once the number 9 is reached, pressing [Y/+] causes the numbers to “wrap around” to 0 and count up again.
5. Once you have set the desired value, press [MODE] for “Done.” This registers the new span value.

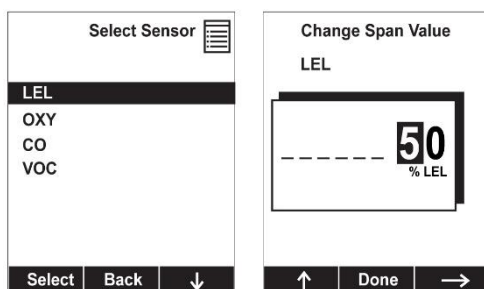

9.3.3.12 Change Span2 Value

If your MultiRAE is equipped with a high-range, or parts-per billion, PID sensor, you can set the span gas value for a third calibration point (Span2). The unit of measure is shown on the display.

1. Press [Y/+] to select the highlighted sensor (VOC).
2. Press [N/-] to step through the digits.
3. Press [Y/+] to increase the number from 0 through 9. Once the number 9 is reached, pressing [Y/+] causes the numbers to “wrap around” to 0 and count up again.
4. Once you have set the desired value, press [MODE] for “Done.” This registers the new Span 2 value.

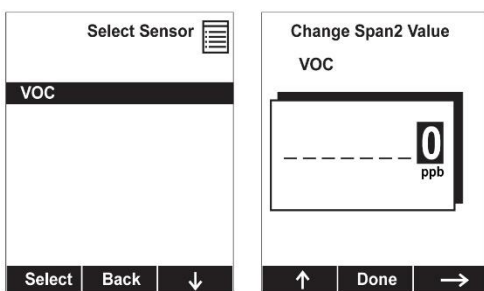

Note: Three-point calibration is disabled by default, but can only be enabled on MultiRAE and MultiRAE Pro instruments with 10.6eV PID sensors, including high-range ppm and ppb PID sensors. The MultiRAE Lite PID sensor only supports 2-point calibration.

9.3.4 Calibrating A PH₃ Sensor Using H₂S Calibration Gas

Using a specially designed PH₃ (Phosphine) sensor in a MultiRAE with firmware version 1.50 or higher, it is possible to calibrate the PH₃ H sensor using H₂S (Hydrogen Sulfide) calibration gas. This simplifies both multi- and single-sensor calibration because it allows calibrating both sensors together, without requiring PH₃ calibration gas.

Note: Two PH₃ sensors are available, so you must use the correct one, P/N: C03-0976-100, if you want to calibrate the PH₃ sensor with H₂S calibration gas (or 4-mix gas containing H₂S).

If the MultiRAE reads the sensor and finds that it is designed for this H₂S/PH₃ calibration, when you view the Multi Cal. Select screen, it shows H₂S and PH₃ selected. Then, if you press [N/-] to see the values of the Span gas the MultiRAE expects. Make sure that the gas values on a 4-mix calibration gas cylinder match the values shown, except for H₂S, which should be 10 ppm (even though the display shows 16 ppm for PH₃). To calibrate multiple sensors, including the specialized PH₃ H sensor, follow the instructions on page 54.

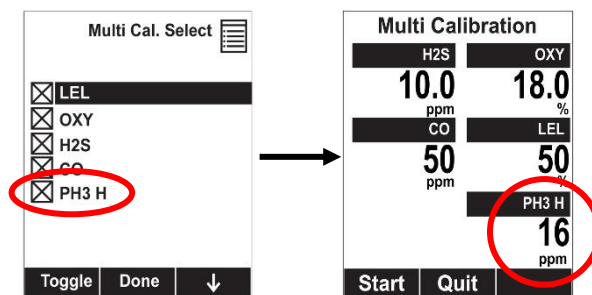

If the MultiRAE reads the sensor and finds that it is not designed for H₂S/PH₃ calibration, when you view the Multi Cal. Select screen, PH₃ is not selected. When you press [N/-] to advance to the values screen, PH₃ is not shown.

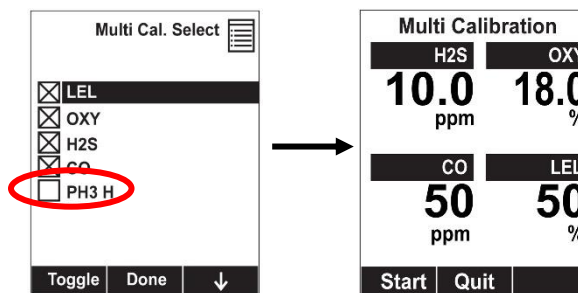

When performing a single-sensor calibration and the instrument is equipped with the specialized PH₃ H sensor, the Span Calibration screen shows the target value of the calibration gas and reminds you to apply gas using 10 ppm H₂S. Follow the standard process outlined on page 55.

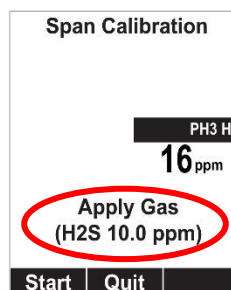

9.3.5 Measurement

The submenus for Measurement include Sensor On/Off, Change Measurement Gas, and VOC and Gamma (if equipped) Measurement Units.

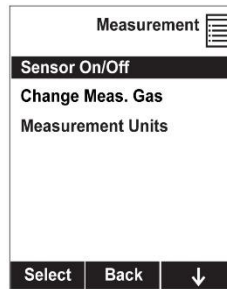

9.3.5.1 Sensor On/Off

You can turn sensors on or off via this submenu. An "X" in a box to the left of a sensor's name indicates it is turned on.

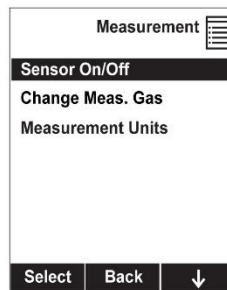

1. Scroll down the list of sensors using the [N/-] key.
2. Add or remove that gas from the list by pressing [Y/+]. An "X" in a box to the left of a sensor's name indicates it is selected.
3. Once you have made all your selections, press [MODE] for "Done."

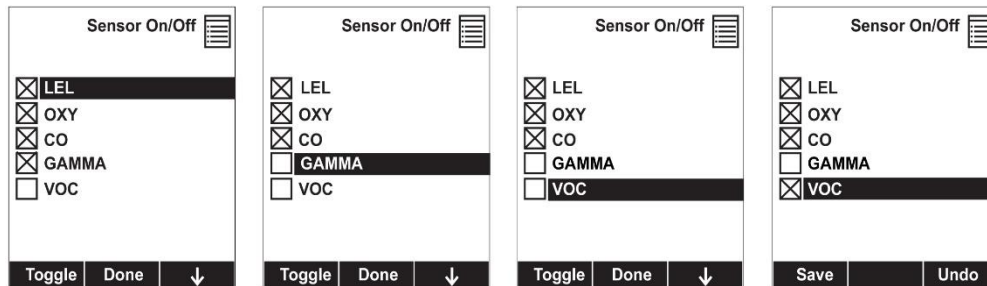

9.3.5.2 Change Meas. Gas

The MultiRAE has extensive onboard gas libraries for combustible gases and VOCs that you can use to configure your MultiRAE to automatically apply the appropriate correction factors and produce readings in the units of the desired combustible gas or VOC.

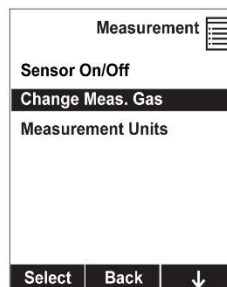

Measurement gases are organized in four lists:

- **My List** is a customized list of gases that you create. It contains a maximum of 10 gases and can only be built in ProRAE Studio II on a PC and transferred to the instrument.
Note: The first gas in the list is always isobutylene (it cannot be removed from the list).
- **Last Ten** is a list of the last ten gases used by your instrument. The list is built automatically and is only updated if the gas selected from Custom Gases or Library is not already in the Last Ten. This ensures that there is no repetition.
- **Gas Library** is a library that consists of more than 200 gases for the PID sensor and more than 50 for the catalytic LEL sensor.
- **Custom Gases** are gases with user-modified parameters. Using ProRAE Studio II, all parameters defining a gas can be modified, including the name, span value(s), correction factor, and default alarm limits.

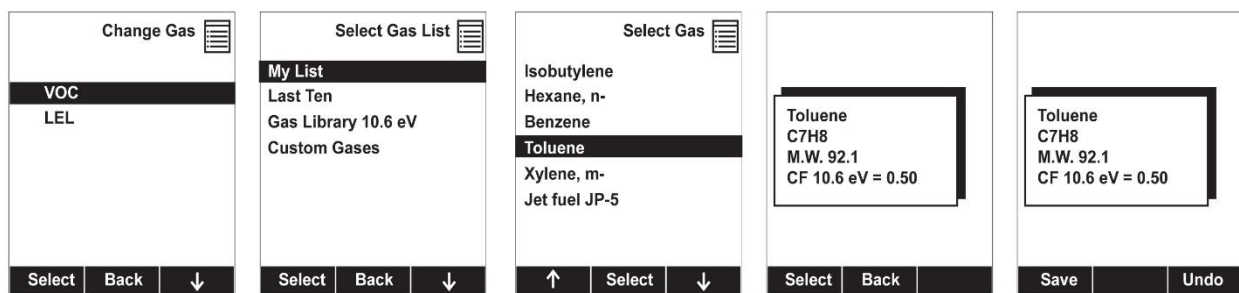

9.3.5.3 Measurement Units

In some cases, the measurement unit for displaying data from sensors can be changed.

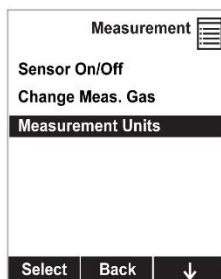

Standard available measurement units include:

Abbreviation	Unit	Sensor Type
ppm, ppb	parts per million, parts per billion	PID for VOC
mg/m3, µg/m3	milligrams per cubic meter, micrograms per cubic meter	PID for VOC
ppm, mg/m3	parts per million, milligrams per cubic meter	EC (electrochemical)
ppm Only, %VOL only, Auto Range	parts per million, percent by volume, automatically switch from ppm to % VOL at 10,000 ppm and higher*	CO ₂
µrem, mrem	microrems and millirems	Gamma
µSv, mSv	microSieverts and milliSieverts	Gamma
µR, mR	microRoentgens and milliRoentgens	Gamma
µGy, mGy	microGrays and milliGrays	Gamma

* The CO₂ switch point from ppm to % VOL can be changed via ProRAE Studio 2.

Here are two examples of menu hierarchies (select the sensor type and then the measurement unit):

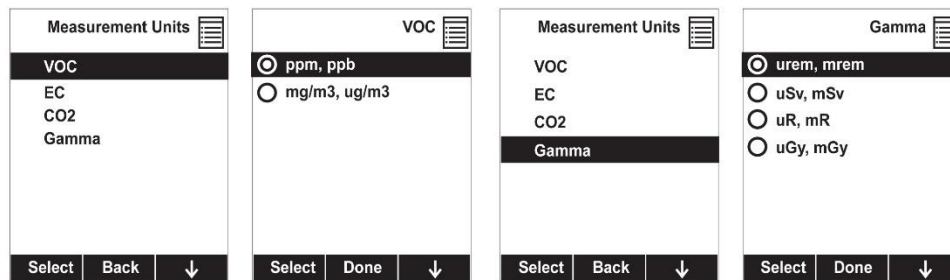

9.3.6 Alarms

Use this menu to change high, low, STEL, and TWA alarm limits - the points at which alarms are triggered. The Alarms menu also allows changing alarm mode (latched or automatic reset) and alarm output methods (combinations of light, buzzer, and vibration alarm indications).

9.3.6.1 Alarm Limits

There are four groups of alarm settings that you can adjust for each individual sensor for which a particular alarm type is available.

Settings:

- High Alarm
- Low Alarm
- STEL (Short-Term Exposure Limit) Alarm
- TWA (Time-Weighted Average) Alarm

Note: Some alarm settings are not applicable to all sensors. If a setting is irrelevant to a sensor (for example, STEL for a gamma radiation sensor), then that sensor does not appear in the list.

9.3.6.2 Alarm Mode

You can program the MultiRAE so that there are two ways to shut off an alarm:

Auto Reset	When the alarm condition is no longer present, the alarm stops automatically.
Latch	You must manually turn off an alarm when one is triggered. The latched setting only controls alarms for High Alarm, Low Alarm, STEL Alarm, and TWA Alarm.

9.3.6.3 Alarm Settings

You can enable/disable any combination of light (visible), buzzer (audible), and vibration alarms.

Settings:

- All Enabled
- Light
- Vibration
- Buzzer
- Buzzer & Light
- Buzzer & Vibration
- Vibration & Light
- All Disabled

9.3.6.4 Comfort Beep

A Comfort Beep is a single beep of the audible alarm at 60-second intervals that informs the person using the MultiRAE that it is functioning. It can be turned on or off.

9.3.6.5 Man Down Alarm

The Man Down Alarm is a critical and potentially lifesaving feature of every MultiRAE. The Man Down Alarm is based on the premise that if the instrument is motionless when it is not supposed to be, something wrong may be happening to its user. If that is the case, a wirelessly enabled MultiRAE not only goes into alarm locally on the instrument to notify people in the vicinity, but also remotely, over a wireless network, to transmit the alarm to remote safety officers at a command center, that a person is down, so that help can be dispatched quickly.

Whenever the Man Down feature is enabled, the main screen displays a Man Down icon along the top to indicate it is active:



The MultiRAE has a 3D gravity sensor that can track the slightest motion of the instrument in any direction. If the instrument is not moved during that time, then a pre-alarm is activated to alert the user, and shows the “Are You OK?” screen. Pressing [Y/+] clears the alarm and returns the MultiRAE to its normal operation. Pressing [N/-] sets it into Man Down Alarm (and if wireless connectivity is enabled, a Man Down message is sent in real time to remote observers). If neither key is pressed, then after the countdown, it goes into Man Down Alarm (again sending a message to remote observers if wirelessly enabled).

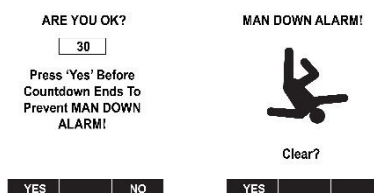

Settings are available for:

- Off/On (off by default)
- Motionless Time: time the instrument is motionless before initiating a pre-alarm (30 seconds by default)
- Motion Sensitivity: set to low, medium, or high to compensate for ambient vibration or motion (medium by default)
- Warning Time: countdown, in seconds, from pre-alarm to Man Down alarm (30 seconds by default)

When the Man Down pre-alarm is activated, the buzzer sounds and LEDs flash twice per second, and a countdown begins.

- If the MultiRAE’s user presses [Y/+] for “Yes” in response to the “Are You OK?” question on the screen before the countdown reaches zero, the Man Down alarm stops and the main reading screen is displayed.
- If the person does not press [Y/+] for “Yes” in response to the “Are You OK?” question on the screen before the countdown reaches zero, the Man Down alarm is triggered.
- If the person presses [N/-] during the countdown, answering the “Are You OK?” question with “No,” the Man Down alarm starts.

If wireless connectivity is enabled, a Man Down message is also sent to remote observers.

IMPORTANT!

When gas or radiation alarm conditions exist at the same time as the Man Down is activated, the pre-alarm stage is skipped and the instrument goes straight into a Super Alarm (gas or radiation and Man Down) with four beeps/flashes per second.

IMPORTANT!

MultiRAE Benzene only: Man Down alarm capability is off during Benzene Mode measurements.

IMPORTANT!

When a MultiRAE is connected to an AutoRAE 2, truck mount, or desktop cradle, the Man Down alarm feature is disabled.

9.3.6.6 Man Down Messaging (Wi-Fi-Equipped Instruments Only)

In addition to the Man Down function in other MultiRAE monitors, instruments equipped with Wi-Fi provide an option for sending a message to ProRAE Guardian.

When the Man Down is triggered, this screen is shown:

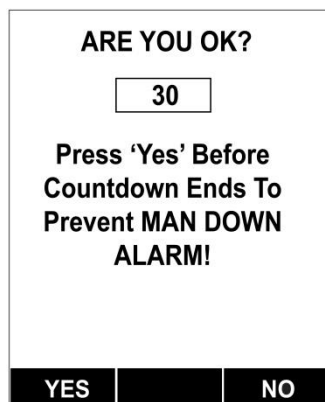

If you do not need assistance, press [Y/+] before the countdown reaches 0 to stop the Man Down alarm from being activated. Otherwise, press [N/+] to trigger the Man Down alarm immediately, or do not press either key (the countdown will reach 0 and the alarm will start). When the Man Down alarm occurs, this screen is displayed:



In addition, the instrument alarms (audible and visible) four times per second. The instrument also sends an emergency message to ProRAE Guardian.

Press [Y/+] to clear the alarm. The alarm stops and the display returns to the main reading screen.

9.3.6.7 Panic Alarm (Wi-Fi-Equipped Instruments Only)

When you hold down the [Y/+] key for more than four seconds, the “Panic Alarm!” screen is shown and the instrument alarms (audible and visible) four times per second.

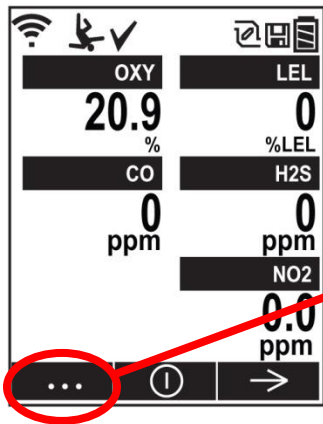

Press and hold [Y/+] to activate Panic Alarm

Instruments equipped with Wi-Fi also send an emergency message to ProRAE Guardian.

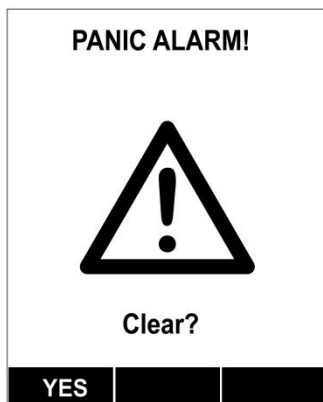

To clear the alarm, press [Y/+].

9.3.7 Quick Access Menu (Wi-Fi-Equipped Instruments Only)

Instruments equipped with Wi-Fi offer a Quick Access Menu that is accessible from the main reading screen. There is also a Panic Alarm, also accessible from the main screen.

The Quick Access Menu is accessed by pressing [Y/+]:

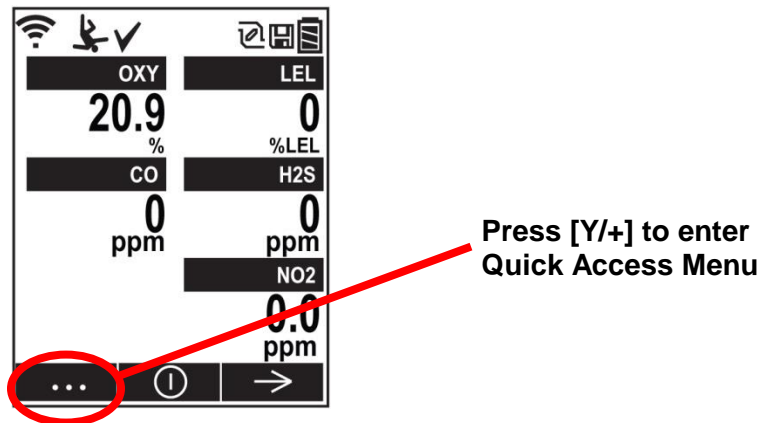

The Quick Access Menu provides three choices. Scroll through them by pressing [N/-], and select one by pressing [Y/+].

Clear Alarm. If an alarm is sounding, press [Y/+]. The alarms are cleared, and the display shows the main reading screen.

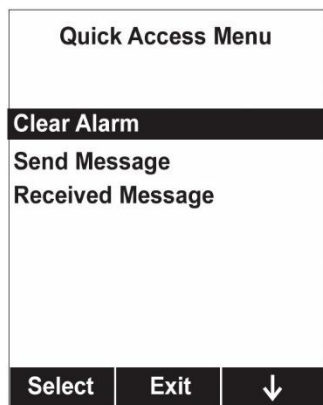

Send Message. Send a preconfigured message via "Send Message." Press [Y/+].

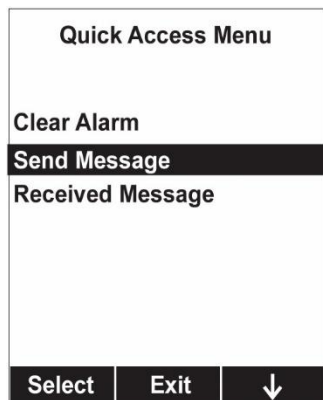

The “Send Message” screen shows the first message and the total number of available stored messages (in this example, 10 messages):

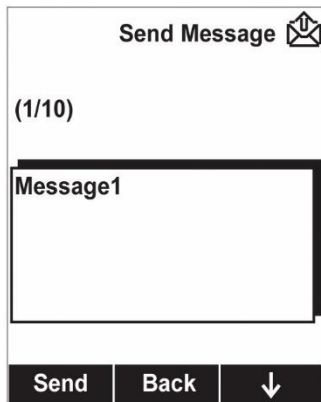

Scroll through the messages by pressing [N/-]. When you reach the message you want to send, press [Y/+]. If the message is sent successfully, this message is show:

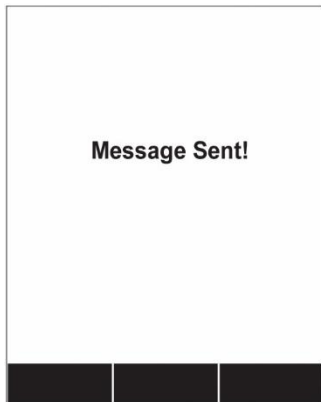

After a few seconds, the display automatically returns to the Send Message screen. If the message was not sent, this message is shown:



After a few seconds, the display automatically returns to the Send Message screen. Check that the radio module is turned on. If it is off, turn it on and try sending the message again.

Received Message. Check for received messages by selecting this option (press [Y/+]).



Press [Y/+] to check for received messages. If there are no received messages, the display alerts you:

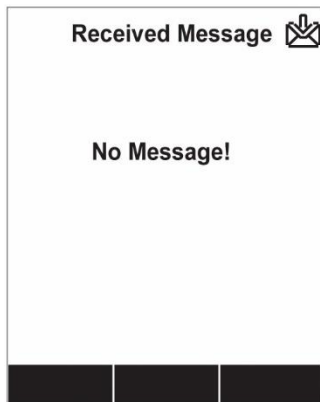

After a few seconds, the display automatically returns to the Quick Access Menu. If there are received messages, the display shows the first one and tells you how many messages it has received, such as 1/6 (first message of six messages), etc. It also shows the time and date when the message was received:

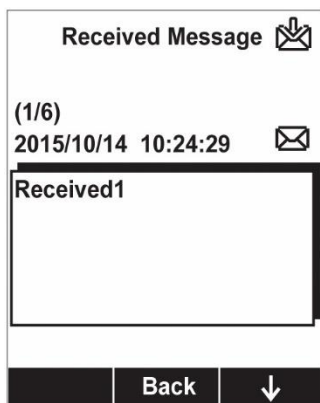

Step through the messages by pressing [N/-].

Return to the Quick Access Menu by pressing [MODE].

9.3.8 Datalog

The instrument displays a floppy disk icon to indicate that a datalog is being recorded. The instrument stores the measured gas concentration for each sensor, date and time for each measurement, Site ID, User ID, and other parameters. The MultiRAE memory is sufficient to record six months' worth of data for five sensors at one-minute intervals, 24/7. All data are retained (even after the unit is turned off) in non-volatile memory so that they can be downloaded at a later time to a PC.

9.3.8.1 Clear Datalog

This operation erases all data stored in the datalog. Select “Clear Datalog,” and then “Yes.”

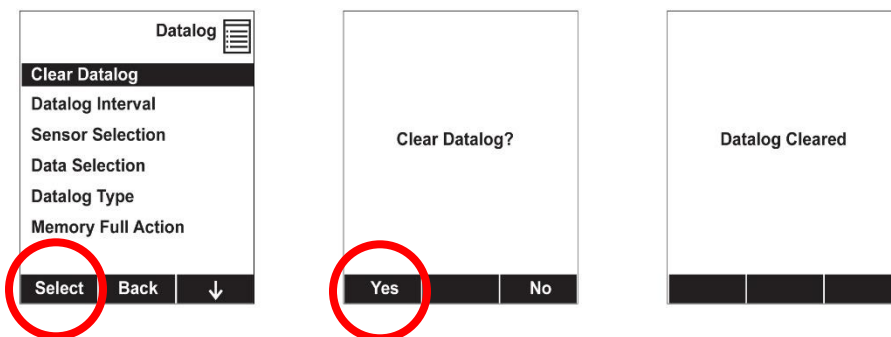

Note: Once the datalog is cleared, the data cannot be recovered.

9.3.8.2 Datalog Interval

Intervals are shown in seconds. The default value is 60 seconds. The maximum interval is 3600 seconds, and the minimum is 1 second.

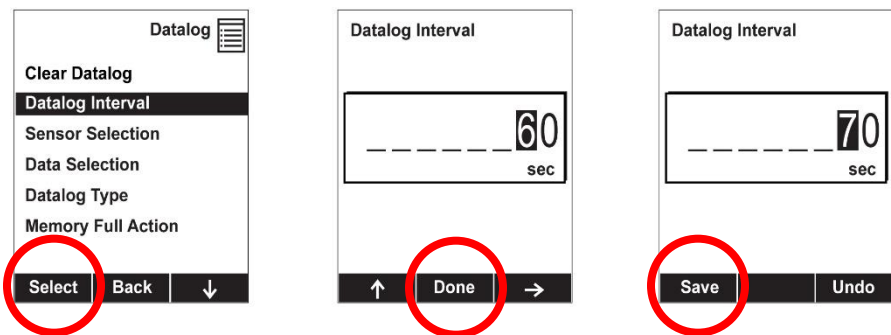

9.3.8.3 Sensor Selection

You can choose which sensors' data are included in the datalog. The entire list of installed sensors is shown, and you can individually select whether their data is included.

Note: Turning a sensor off in the list does not change or erase its settings.

9.3.8.4 Data Selection

Data Selection allows you to select which types of data are stored and made available when you download your datalog to a computer via ProRAE Studio II (version 1.04 or higher) software.

You can choose any or all of four types of data (you must choose at least one):

- Minimum
- Average
- Maximum
- Real Time

9.3.8.5 Datalog Type

The instrument offers three options for starting the datalogging process:

Auto	Automatically collects datalog information every time the instrument is sampling until the datalog memory is full.
Manual	Datalogging occurs only when you manually initiate it (see below for details).
Snapshot	Captures a single event when you press [MODE].

Note: You can only choose one datalog type to be active at a time.

About Manual Datalogging

When the instrument is set to Manual Datalog, you can turn datalogging on and off by repeatedly pressing [N/-] and stepping through the screens from the main display until you reach the screen that says “Start Datalog?”

- When you reach the screen that says “Start Datalog?” press [Y/+] to start it. You see “Datalog Started,” confirming that datalogging is now on. You can turn it off by pressing [Y/+] again.
- If datalogging is running, you can leave it running. However, if you want to turn it off, follow this procedure:

Press [N/-] repeatedly to step through the screens until you reach the screen that says, “Stop Datalog?” Press [Y/+] to stop datalogging. The screen displays “Datalog Stopped” for a few seconds, before displaying “Start Datalog?” and the datalog interval. You can restart it anytime by pressing [Y/+] from that screen.

About Snapshot Datalogging

When the instrument is in Snapshot datalogging mode, it captures a single “snapshot” of the data at the moment of your choosing. All you have to do is press [MODE] each time you want to capture a snapshot of the data at that instant.



No snapshot.



Press [MODE] for a snapshot.



Datalog icon is shown momentarily during a snapshot

9.3.8.6 Memory Full Action

When the internal datalog memory is full, the MultiRAE can either stop collecting data (Stop when full) or go back to the beginning and overwrite the data from the first entry, second entry, etc. (Wraparound).

9.3.9 Wireless

When a MultiRAE is equipped with a wireless modem, its settings are controlled via the menu items under “Wireless.”

Note: Instruments equipped with Wi-Fi provide different menu choices. Refer to page 78 for details.



9.3.9.1 Radio ON/OFF

Turn the radio on or off via this menu.

1. Choose between “On” and “Off” by pressing [N/-].
2. Select the highlighted state by pressing [Y/+].
3. Save or register the change:
 - Press [Y/+] to save the change.
 - Press [N/-] to undo the change.

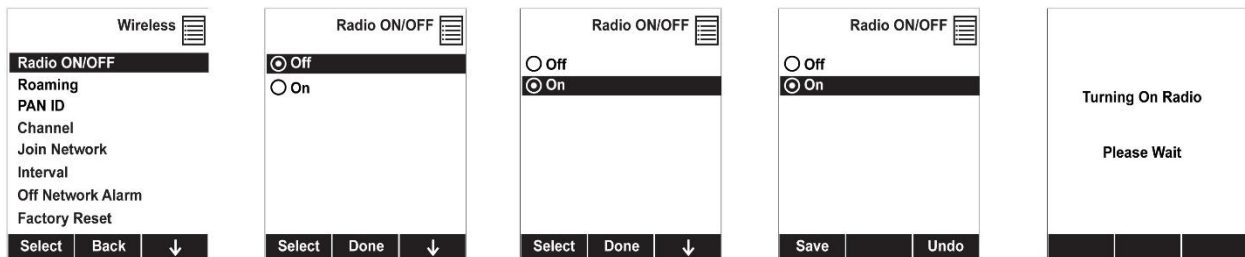

9.3.9.2 Roaming

The Roaming function provides continuous wireless connectivity between zones enabling users of wireless monitors to travel from one zone/work area to another without losing communication between their monitor and ProRAE Guardian. You can turn Roaming on and off in your monitor, or you can set it via ProRAE Studio II.

1. Press [N/-] to scroll down to “Roaming.”
2. Press [Y/+] to select “Roaming.”
3. Press [Y/+] to scroll to “On” or “Off.”
4. Press [Y/+] to “Save.”

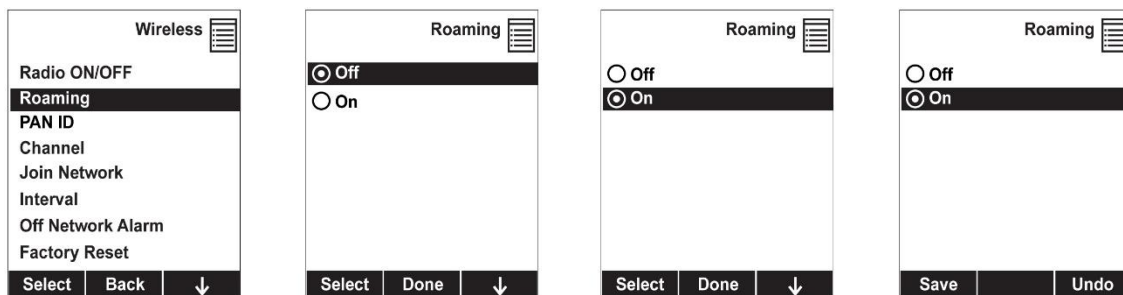

Note: When Roaming is on, you cannot change the instrument's PAN ID. When Roaming is on, the "PAN ID" is not shown in the Wireless menu. To turn "PAN ID" back on:

1. In the Wireless menu, press [N/-] to scroll down to "Roaming."
2. Press [Y/+] to select "Roaming."
3. Press [Y/+] to select "Off."
4. Press [Y/+] to save the change.

Roaming is now off, and the "PAN ID" menu item is now visible and selected.

9.3.9.3 PAN ID

The MultiRAE and any other devices that you want to interconnect wirelessly must have the same PAN ID. You can set the PAN ID in the instrument or through ProRAE Studio II. **Note:** When Roaming is turned on, the PAN ID menu item is unavailable and therefore the PAN ID cannot be changed. To make the menu item available and to change the PAN ID in the instrument, turn Roaming off.

1. Press [Y/+] to increase the number and [N/-] to advance to the next digit.
2. After moving to the last digit and making changes, press [MODE].
 - Press [Y/+] to save the change.
 - Press [N/-] to undo the change.

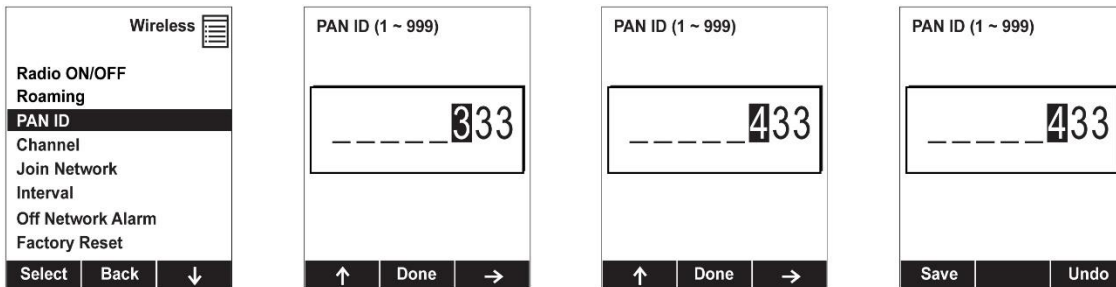

9.3.9.4 Channel

The MultiRAE and any other devices that you want to interconnect wirelessly must be operating on the same channel.

1. Press [Y/+] to increase the number and [N/-] to advance to the next digit.
2. After moving to the last digit and making changes, press [MODE].
 - Press [Y/+] to save the change.
 - Press [N/-] to undo the change.

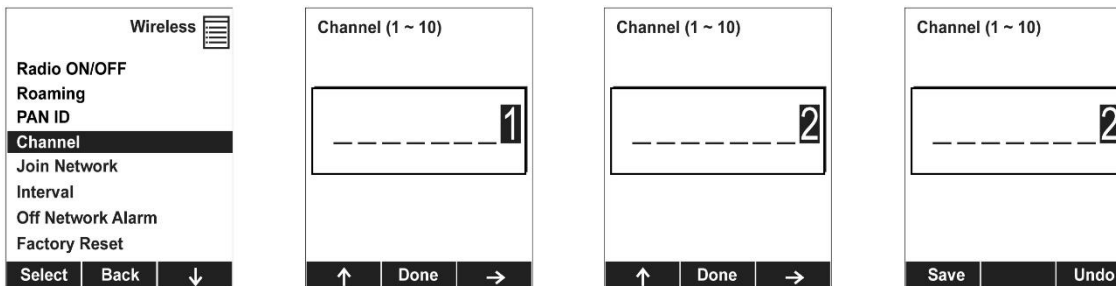

Note: You cannot change the channel setting on an instrument equipped with a radio modem that operates at a frequency of 868 MHz.

9.3.9.5 Join Network

You can tell the MultiRAE to automatically join a network with a certain PAN ID without having to specify the communications channel. The PAN ID is shown for reference (if it is incorrect, you can change it in ProRAE Studio II). Press [Y/+] to join. **Note:** If Roaming is turned on, instead of a PAN ID number, you see “- - -”.

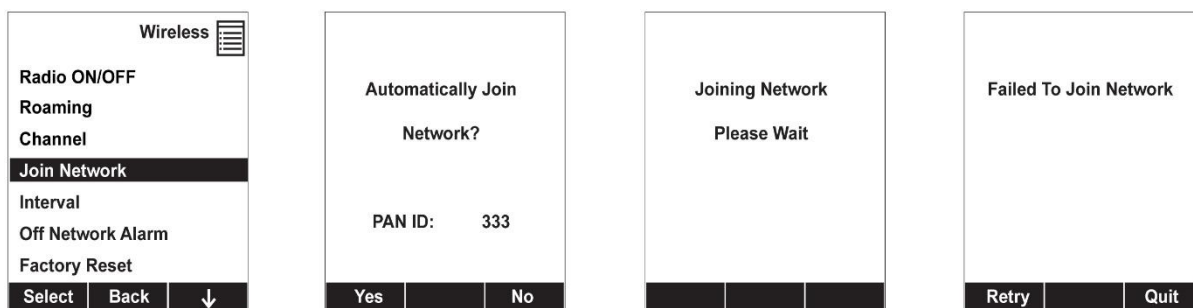

While it is searching for a network to join, the display shows this message:

Joining Network
Please Wait

If it is unsuccessful, you will see this message:

Failed To Join Network

Check your other settings, as well as those of the network you are trying to join.

You can press [Y/+] to retry or [N/-] to quit.

9.3.9.6 Interval

This menu allows you to change the interval between wireless transmissions. The interval can be set to 10, 30, 60, 120, or 240 seconds.

1. Scroll down the list of intervals by pressing [N/-] until the interval you want is highlighted.
2. Select the highlighted interval by pressing [Y/+].
3. Save or register the change:
 - Press [Y/+] to save the change.
 - Press [N/-] to undo the change.

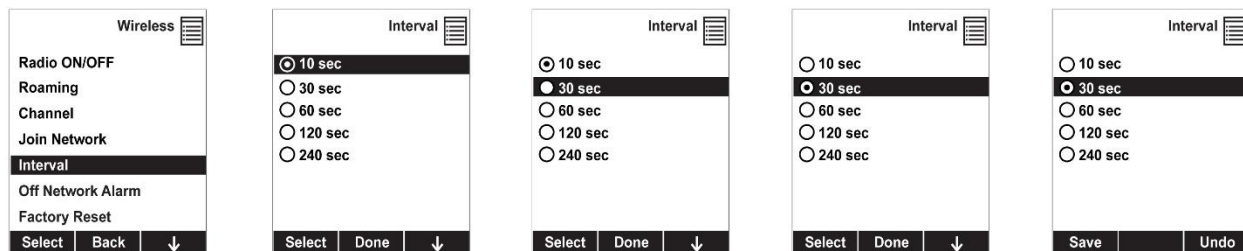

Note: The default interval is 30 seconds.

Note: When in TVOC Mode, MultiRAE Benzene behaves exactly like other models. In Benzene Mode, however, ProRAE Guardian shows “sampling” during countdowns and then continuously shows snapshot measurement of “Benzene: XXppm” until new measurement is done or until the instrument is used in TVOC mode.

9.3.9.7 Off Network Alarm

If you would like the MultiRAE to notify you when it loses connection with a network, turn this on.

1. Choose between “On” and “Off” by pressing [N/-].
2. Select the highlighted state by pressing [Y/+].
3. Register the change.
 - Press [Y/+] to save the change.
 - Press [N/-] to undo the change.

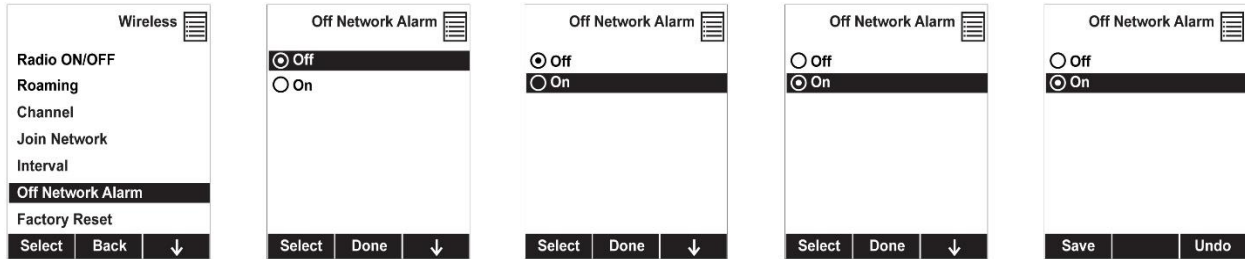

9.3.9.8 Factory Reset

Restore all the wireless settings to their original factory defaults.

Caution! Once you reset the wireless settings, you cannot retrieve any of the settings deleted by performing this reset.

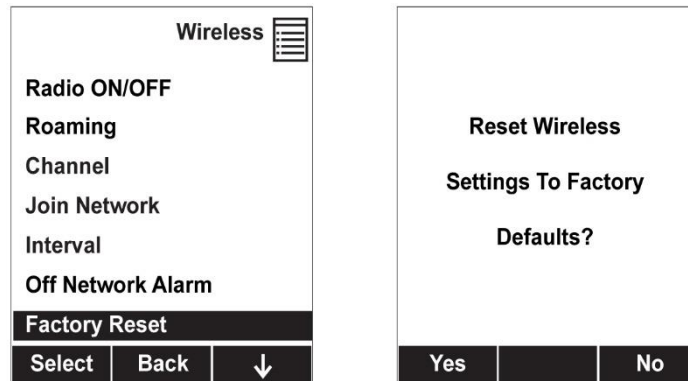

- Press [Y/+] to reset the wireless settings.
- Press [N/-] to exit without resetting the wireless settings.

9.3.10 Wireless (Instruments Equipped With Wi-Fi Only)

To change wireless settings on instruments equipped with Wi-Fi, go to “Wireless” in Programming Mode:

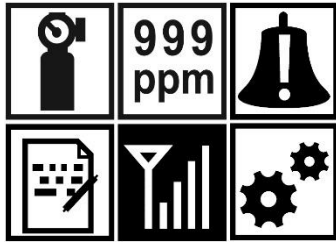

Press [Y/+] to enter the Wireless menu.

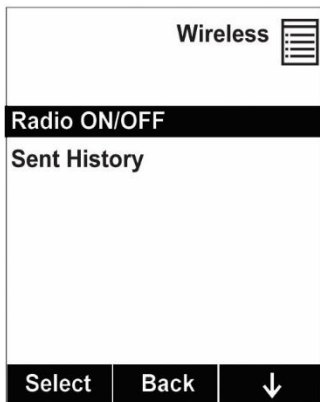

Radio ON/OFF. Press [Y/+] to select “Radio On/Off.”

Press [N/-] to select “Off” or “On.”

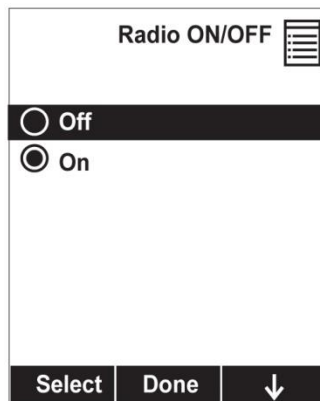

Press [Y/+] to save or [N/-] to undo. If you choose to turn the radio on and save the change, the screen tells you that it is turning the radio on, followed by a screen that says “Radio On” once the radio is on. Then it returns to the main Wireless menu.

Sent History. You can view messages that have been sent by selecting “Sent History.”

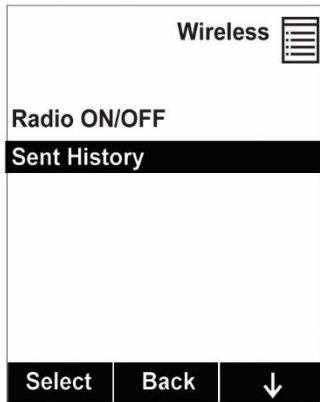

Press [Y/+] to view messages that have been sent. If no messages have been sent, then the display shows this screen:

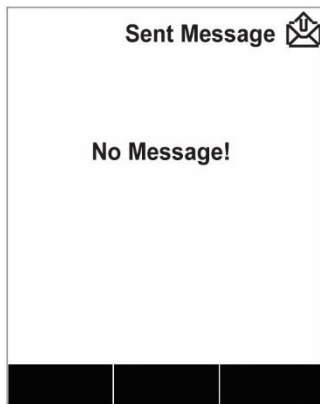

After a few seconds, it automatically returns to the Wireless menu. If messages have been sent, the display shows the first one and tells you the total number of messages sent (such as 1/5, first message of five messages, etc.). It also shows the time and date when the message was sent:

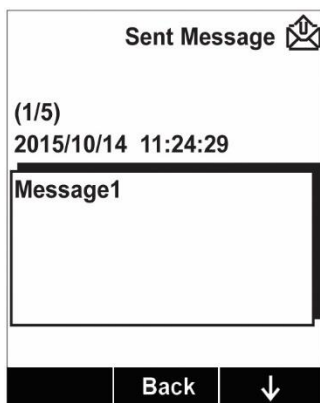

Step through the sent messages by pressing [N/-], or return to the Wireless menu by pressing [MODE].

9.3.11 Monitor

The submenus under “Monitor” control the LCD’s contrast, operation mode, pump speed, and other parameters. Press [N/-] to advance through the submenus, and when you reach the last one, it returns to the first selection.

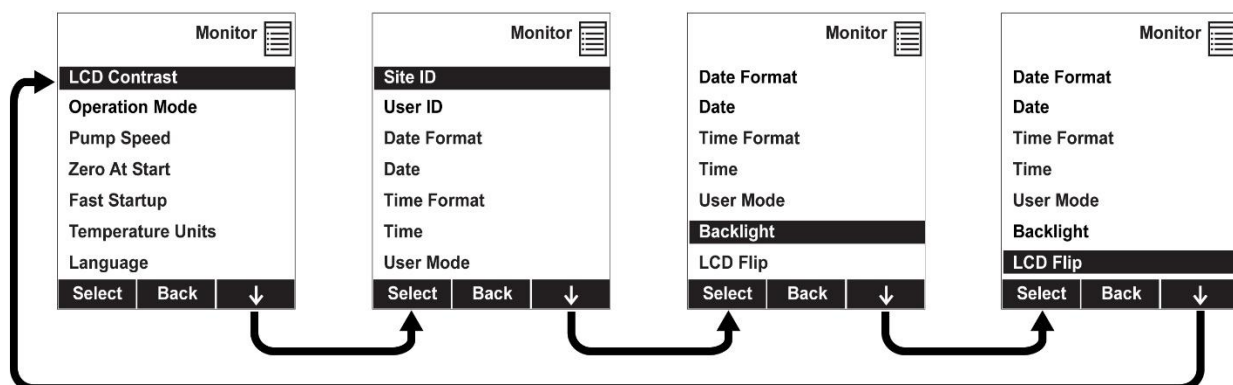

9.3.11.1 LCD Contrast

The display’s contrast can be increased or decreased from its default setting. You may not need to ever change the default setting, but sometimes you can optimize the display to suit extreme temperature and ambient brightness/darkness conditions.

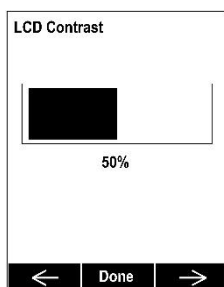

Use the [Y/+] and [N/-] keys to decrease or increase LCD contrast, respectively (the bar graph aids in setting it). When you are done, press [MODE] to select “Done.” If you have not made a change, it exits to the submenu’s next selection. If you have made a change, you are prompted at the next screen to press [Y/+] to save the change or [N/-] to undo the change and exit to the next submenu selection.

9.3.11.2 Operation Mode

There are two operation modes, outlined below.

Hygiene Mode

When the MultiRAE is in Hygiene Mode, it continuously monitors, and if datalogging is on, it saves data continuously. Refer to page 42 for more information on operation in Hygiene Mode.

Search Mode

When the instrument is in Search Mode, it only samples when you activate sampling. When you see the display that says, “Ready...Start sampling?” press [Y/+] to start. The instrument automatically assigns a new Site ID to each measurement you take. The pump turns on and the instrument begins collecting data. To stop sampling, press [N/-] while the main display is showing. You will see a new screen that says, “Stop sampling?” Press [Y/+] to stop sampling. Press [N/-] if you want sampling to continue. Refer to page 42 for more information on operation in Search Mode.

9.3.11.3 Pump Speed

If the MultiRAE is equipped with a pump, the pump can operate at two speeds, high and low. Running at low speed is quieter, extends pump lifespan, and conserves a small amount of power. There is almost no difference in sampling accuracy.

9.3.11.4 Zero At Start

If your MultiRAE has been configured to perform a zero (fresh air) calibration upon startup, called Zero At Start, then the startup routine is interrupted so that you can perform a fresh air calibration for all sensors prior to using the instrument.

If you do not want to perform a zero calibration, press [MODE] to bypass it. If you start a zero calibration and want to abort it, press [N/-], and the calibration stops and the main display is shown.

9.3.11.5 Fast Startup

Fast Startup reduces the amount of time between when the instrument is turned on and is ready for use. It skips showing you many settings and is best suited to environments where the MultiRAE is turned on and off very often during a given day. If Fast Startup is not selected, then when the instrument starts, it shows you details of each sensor, including calibration information, high and low alarm settings, etc.

Benzene Mode (MultiRAE Benzene Only)

The MultiRAE Benzene does not have Search Mode. It operates in TVOC MODE (equivalent to Hygiene Mode) or Benzene Mode.

9.3.11.6 Temperature Units

The display unit of the internal temperature sensor can be switched between Fahrenheit and Celsius.

9.3.11.7 Language

English is the default language, but other languages can also be selected for the instrument. **Note:** The language can only be changed through ProRAE Studio II.

9.3.11.8 Site ID

Choose and enter an 8-digit Site ID to uniquely identify the particular site where the instrument is to be used. The first four digits can be an alphabet letter or number, while the last four digits can only be numbers. This Site ID is included in the datalog report.

Note: Advance through the alphabet and numbers (0 through 9) by one with each press of the [Y/+] key. To scroll quickly, hold down the [Y/+] key for as long as you want it to scroll rapidly.

9.3.11.9 User ID

Enter an 8-digit alphanumeric User ID to uniquely identify a user. This User ID is included in the datalog report. The first four characters of a customized User ID act as an identifier for the monitor on the screen of the EchoView Host Wireless Mini-Controller to which the MultiRAE is wirelessly connected.

Note: Advance through the alphabet and numbers (0 through 9) by one with each press of the [Y/+] key. To scroll quickly, hold down the [Y/+] key for as long as you want it to scroll rapidly.

9.3.11.10 Date Format

Month (MM) and Day (DD) have two digits each, while the year (YYYY) uses four digits. The Date can be expressed in three different formats:

- MM/DD/YYYY
- DD/MM/YYYY
- YYYY/MM/DD

9.3.11.11 Date

Set the date according to the format selected in Date Format.

9.3.11.12 Time Format

The time format can be either of these two options:

- 12 Hour (AM/PM)
- 24 Hour

9.3.11.13 Time

Regardless of the Time Format you select, the MultiRAE's time must be set using the 24-hour format, following hours, minutes, and seconds (HH:MM:SS).

9.3.11.14 User Mode

Two User Modes are available: Advanced and Basic. The Advanced User Mode allows a greater number of parameters to be changed than Basic User Mode. It can be used with either of the Operation Modes, Hygiene or Search. No password is required to enter the Programming Menu when in Advanced User Mode.

9.3.11.15 Backlight

The display's backlight can be set to illuminate either automatically, based on ambient light conditions, or manually, or it can be shut off. If manual backlighting is selected, when the backlight is turned off, pressing any key turns backlighting on. A key needs to be pressed again to perform its main function.

9.3.11.16 LCD Flip

The display can be configured to flip 180° automatically when the MultiRAE is turned upside-down. The LCD Flip feature can be set to On or Off.

Note: When LCD Flip is enabled and the instrument is inverted, the screen flips, and the button functions also "flip" so that their orientation changes, as well.

10 Policy Enforcement

The MultiRAE can be configured to enforce a facility/company's requirements that calibration and/or bump testing be performed at specified intervals, and to explicitly prompt the user that calibration/bump testing is required. Depending on how Policy Enforcement features are configured, the user may be required to perform a bump test or calibration prior to being able to use the instrument. That is, it can be set to not allow normal operation of the instrument unless calibration or bump testing is performed.

If the instrument has been bump tested and calibrated in compliance with the policy settings, a check-mark icon is included along the top of the MultiRAE screen:



If Policy Enforcement is enabled, then after startup the MultiRAE displays a screen that informs the user that the instrument requires either a bump test or a calibration. If both are required, then they are shown in sequence.

Note: Policy enforcement features are disabled by default.

10.1 Setting Policy Enforcement

You must use ProRAE Studio II to make changes to Policy Enforcement settings. The procedure differs, depending on whether you are using an AutoRAE 2, a MultiRAE Travel Charger, or a MultiRAE Desktop Cradle. Policy violations are captured in the datalog.

10.1.1 Using The AutoRAE 2 Automatic Test And Calibration System

To program a MultiRAE via an AutoRAE 2, you need ProRAE Studio II Instrument Configuration and Data Management Software, the AutoRAE 2 connected to a power source, and a USB PC communications cable.

1. Connect a USB cable between a PC with ProRAE Studio II and the AutoRAE 2.
2. Apply power to the AutoRAE 2.
3. Turn off the MultiRAE (or put the MultiRAE into AutoRAE 2 Mode) and set it in the cradle.
4. Start ProRAE Studio II software on the PC.
5. Select "Administrator" and input the password (the default is "rae").
6. Click "Detect the instruments automatically" (the magnifying glass icon with the letter "A" in it). After a few seconds, the AutoRAE 2 Cradle is found and it is shown, along with its serial number:

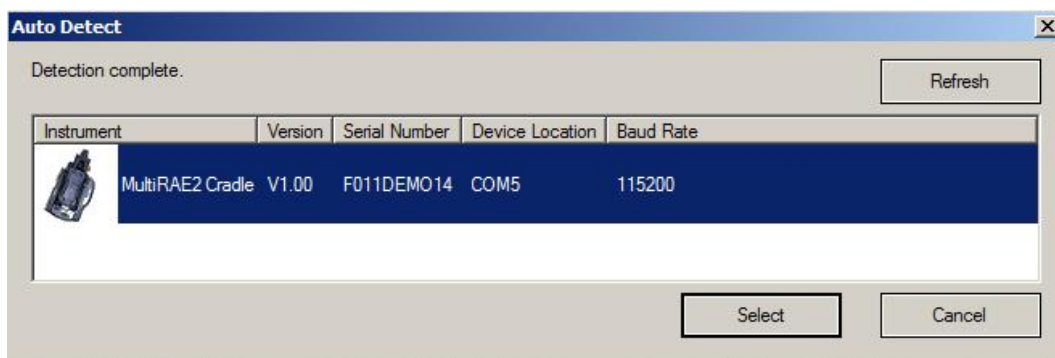

7. Click on the icon to highlight it, and then click "Select."

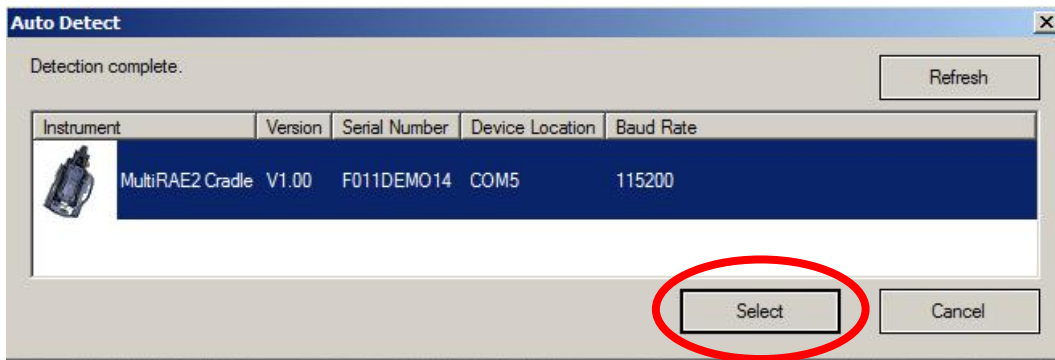

8. In ProRAE Studio II, the AutoRAE 2 Cradle is shown, including its Serial Number, under “Online”:

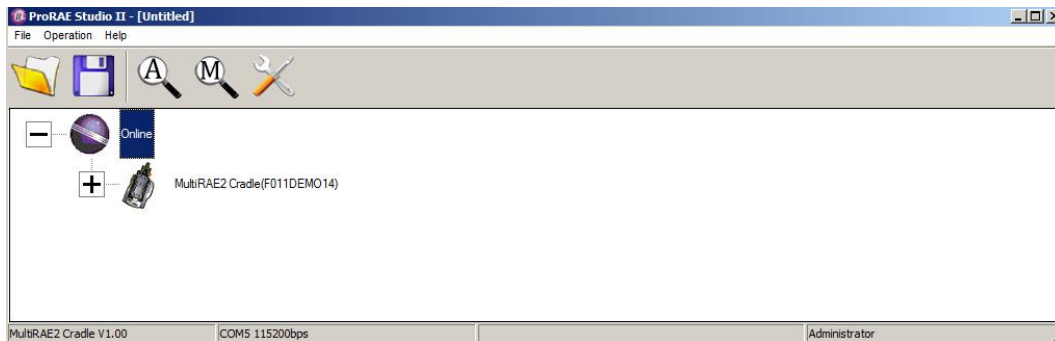

9. Expand the view to show the MultiRAE in the AutoRAE 2 Cradle by clicking the “+” to the left of the image of the AutoRAE 2 Cradle:

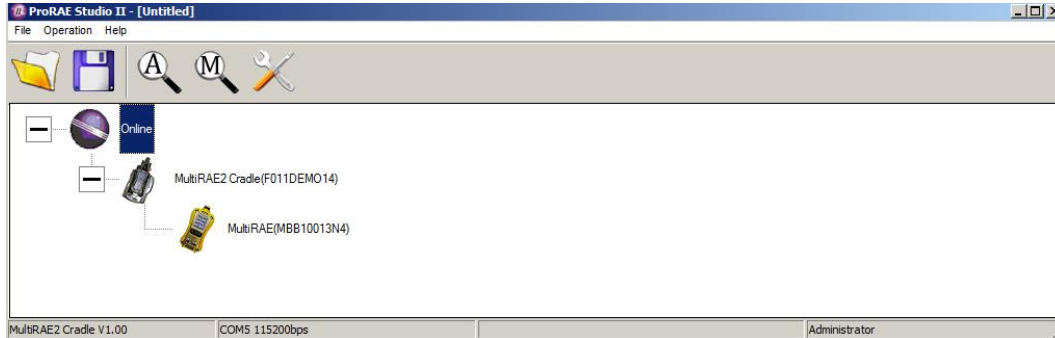

10. Double-click on the icon representing the MultiRAE.

11. Click “Setup.”

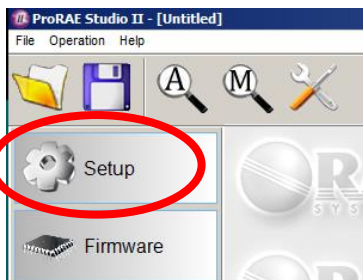

12. In the menu that now appears on the left side, click “Policy Enforcement.” It is highlighted, and the Policy Enforcement pane is shown:

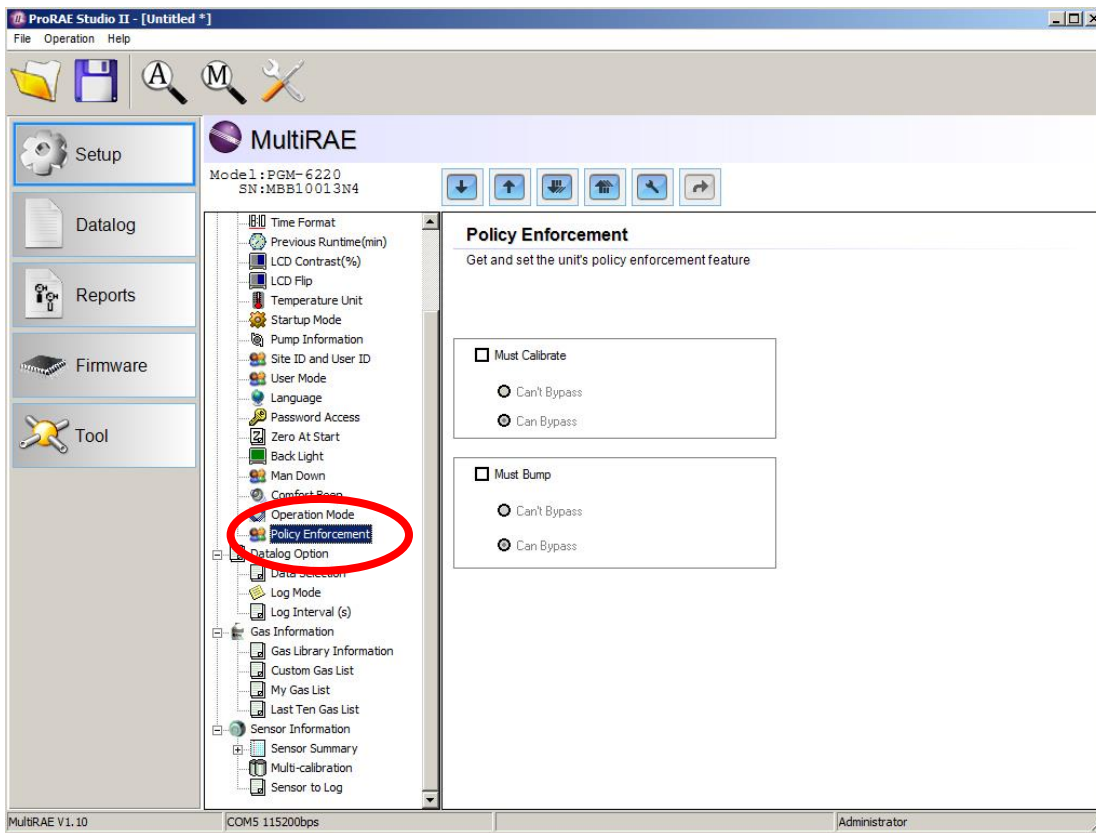

For “Must Calibrate” and “Must Bump,” you have the options of no enforcement or enforcement (including “Can’t Bypass,” and “Can Bypass”).

Must Calibrate. The user is prompted to calibrate the instrument when calibration is due (as set by the calibration interval). There are two programmable options:

- **Can’t Bypass.** Unless calibration is performed, the instrument cannot be used, and the only option is to turn off the instrument.
- **Can Bypass.** If calibration is due but the user does not want to perform a calibration, the instrument can still be used. In this case, the instrument records that the user has bypassed the calibration requirement in a Policy Violation report.

Must Bump. The user is prompted to bump test the instrument when a bump test is due (as set by the bump test interval). There are two programmable options:

- **Can’t Bypass.** Unless a bump test is performed, the instrument cannot be used, and the only option is to turn off the instrument.
- **Can Bypass.** If a bump test is due but the user does not want to perform one, the instrument can still be used. In this case, the instrument records that the user has bypassed the bump testing requirement in a Policy Violation report.

These are the screens that are shown on a MultiRAE after startup if “Can Bypass” is selected:

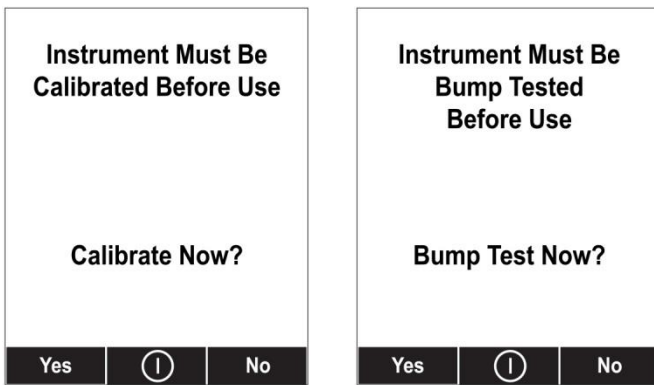

If “Can’t Bypass” is selected, the display looks like this, and only allows the options of performing the test or shutting down:

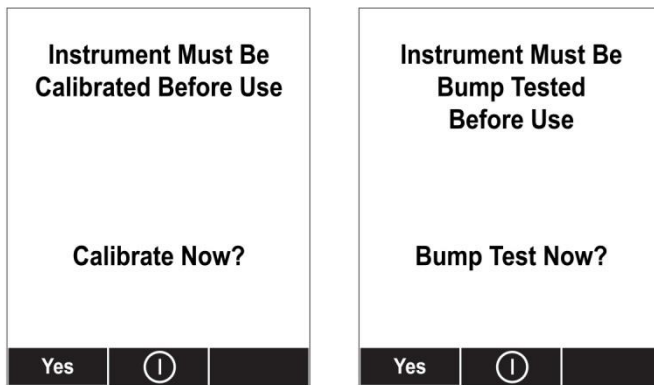

16. Once you have made your selections in ProRAE Studio II, you must upload the changes to the instrument. Click the icon labeled “Upload all settings to the instrument.”
17. A confirmation screen is shown. Click “Yes” to perform the upload, or “No” to abort. Uploading takes a few seconds, and a progress bar is shown. You can abort the upload by clicking “Cancel.”
18. Exit ProRAE Studio II.
19. Press [Y/+] on the MultiRAE to exit Communication Mode.

10.1.2 Using The MultiRAE Desktop Cradle Or Travel Charger

Make sure the AC adapter is connected and that a USB cable is connected to a computer running ProRAE Studio II.

1. Turn on the MultiRAE.
2. Hold down [MODE] and [N/-] to enter Programming Mode.
3. Provide the password.
4. Press [N/-] until “Enter Communications Mode?” is displayed.
5. Press [Y/+]. The screen shows three options:
 - PC
 - AutoRAE 2
 - Exit
6. With “PC” highlighted, press [Y/+] to select it.
The screen now displays: “Ready To Communicate With Computer.”
7. Start ProRAE Studio II.
8. Select “Administrator.”
9. Input the password (the default is “rae”).
10. Click “OK.”
11. Click “A” (detects instruments automatically).
12. Click on the instrument’s icon when it appears to highlight it.
13. Click “Select.”
14. Click “Setup.”
15. Click “Policy Enforcement.”

The Policy Enforcement pane is shown:

Policy Enforcement
Get and set the unit's policy enforcement feature

Must Calibrate

Can't Bypass
 Can Bypass

Must Bump

Can't Bypass
 Can Bypass

You can select “Must Calibrate” and/or “Must Bump” and then set whether the user must perform the selected operation in order to use the instrument.

16. Once you have made your selections in ProRAE Studio II, you must upload the changes to the instrument. Click the icon labeled “Upload all settings to the instrument.”



17. A confirmation screen is shown. Click “Yes” to perform the upload, or “No” to abort.

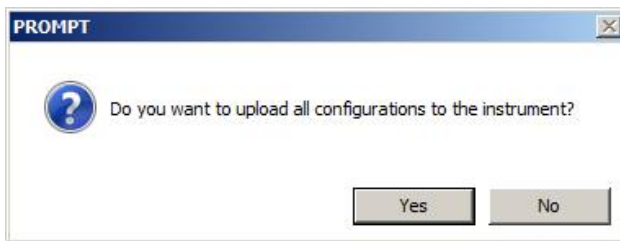

Uploading takes a few seconds, and this progress bar is shown. You can abort the upload by clicking “Cancel.”

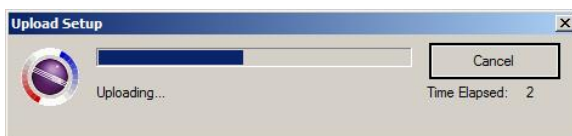

18. Exit ProRAE Studio II.
19. Press [Y/+] on the MultiRAE to exit Communication Mode.

10.2 Deactivating Policy Enforcement

10.2.1 AutoRAE 2 Cradle

To deactivate Policy Enforcement when using an AutoRAE 2 Cradle, follow the procedure for changing settings. See page 83 for details.

10.2.2 MultiRAE Desktop Cradle Or Travel Charger

If the MultiRAE screen displays the message that it must be bump tested or calibrated, and if the option to bypass bump testing or calibration is not available, you should shut off the instrument and follow the procedure outlined here if you want to change the Policy Enforcement settings:

1. Use a USB cable to connect the MultiRAE in its Travel Charger or Desktop Cradle to a computer running ProRAE Studio II.
2. Enter Diagnostic Mode on the MultiRAE (with the instrument turned off, press and hold [Y/+] and [MODE] until it starts up).
3. After startup, enter the password when prompted (default is “0000”) and press [MODE].
4. Press [N/-] repeatedly until you see the “Enter Communications Mode?” screen.
5. Press [Y/+] to enter Communications Mode.
6. Start ProRAE Studio II.
7. Select “Administrator.”

8. Input the password (the default is “rae”).
9. Click “OK.”
10. Click “A” (detect instruments automatically).
11. Click on the instrument’s icon when it appears.
12. Click “Select.”
13. Click “Setup.”
14. Click “Policy Enforcement.” The Policy Enforcement pane is shown.
15. Deselect Policy Enforcement features you do not wish to use.
16. Click “Upload all settings to the instrument.”



17. When you see this confirmation. Click “Yes.”

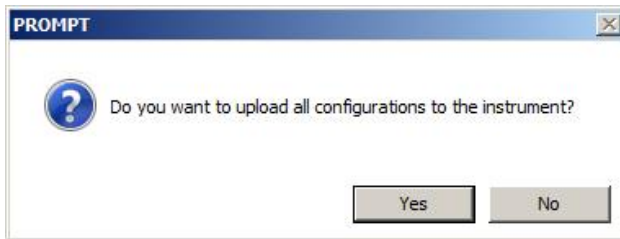

Uploading will take a few seconds, and this progress bar is shown:

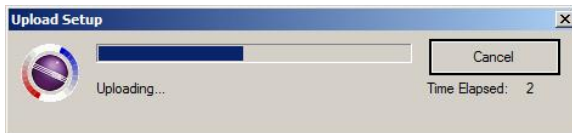

18. When the upload is done, exit ProRAE Studio II.
19. Press [Y/+] on the MultiRAE to exit Communication Mode.

11 Calibration And Testing

11.1 Manual Alarms Test

Under Normal Operation Mode and non-alarm conditions, the buzzer (audible alarm), vibration, visible alarms, and backlight can all be tested anytime by pressing [Y/+] twice. If any alarm does not respond, check the alarm settings in the Programming Menu to make sure all alarms are enabled (selected setting under Programming/Alarms/Alarm Settings should be “All Enabled”). If any alarms are enabled but not functional, the instrument should not be used.

11.2 Bump Testing And Calibration

RAE Systems recommends that a bump test be conducted prior to each day’s use. The purpose of a bump test is to ensure that the instrument’s sensors respond to gas and all the alarms are enabled and functional.

- The MultiRAE multi-gas detector must be calibrated if it does not pass a bump test when a new sensor is installed, after sensor maintenance has been performed, or at least once every 180 days, depending on use and sensor exposure to poisons and contaminants.
- Calibration and bump test intervals and procedures may vary due to national legislation and company policy.

A bump test or calibration can be performed either manually or using the AutoRAE 2 Automatic Test and Calibration System. When a bump test or calibration is done manually, the instrument makes a pass/fail decision based on sensor performance, but the user still has the responsibility to make sure all the alarms are enabled and functional.

An AutoRAE 2 bump test or calibration takes care of both the sensor and alarm tests. Consult the AutoRAE 2 User’s Guide for details.

11.2.1 MultiRAE Equipped With A Pump

With its pump speed setting of low or high, a MultiRAE normally draws in air at a flow rate of between 200 cc/min and 300 cc/min. RAE Systems recommends that a calibration adapter used with calibration gas flow rates from 500 cc/min to 1000 cc/min.

Installing The Calibration Adapter

WARNING: Make sure the calibration adapter clips on and stays in the correct position during calibration, as illustrated below. Otherwise, the calibration adapter must be manually held in the correct position.

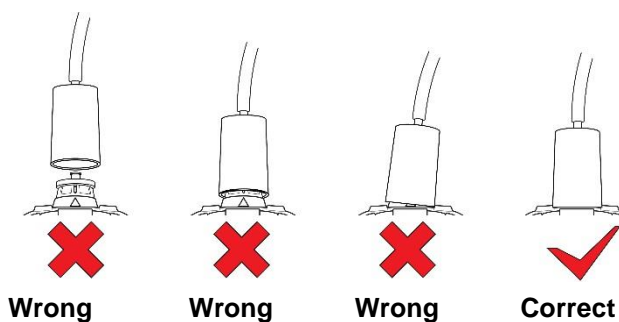

11.2.2 MultiRAE Lite Diffusion Model (No Pump)

Because there is no single inlet on the diffusion (non-pumped) version of the MultiRAE, a Calibration Adapter is used for supplying calibration gas to all sensors at one time. Follow these steps for attaching the Calibration Adapter.

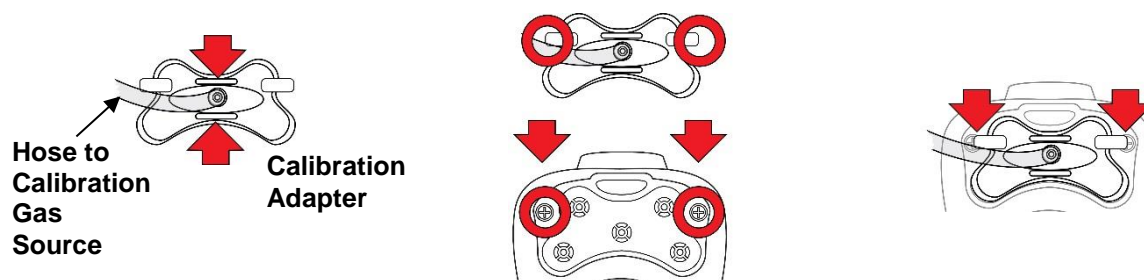

Grasp the small handles on the Calibration Adapter.

Align the Calibration Adapter's two connectors with the screws on both sides of the MultiRAE's gas inlets.

Make sure the connectors are securely in place before starting the flow of calibration gas. (The Calibration Adapter has small grooves on its underside to allow gas to escape after passing over the sensors.)

11.2.3 Bump (Functional) Testing

A bump test can be performed on an individual sensor (Single Sensor Bump) or a group of sensors (Multi Sensor Bump) combined into Multi Cal. Select. The same gas is used for a bump test as for calibration. Typically, two cylinders of calibration gas are needed to perform a bump test or calibration on an instrument with a PID sensor and electrochemical and LEL sensors. This may require one gas cylinder with Isobutylene or another VOC test gas to test the PID sensor, and another with a 4-gas mix to test electrochemical (such as CO, H₂S, and O₂) and LEL sensors. As with calibration, the instrument intelligently splits the process into two consecutive steps: first, the wizard prompts for testing electrochemical and LEL sensors, and then it tests the PID sensor.

For a manual bump test, a constant-flow regulator producing 0.5 to 1 liters per minute should be used, and the calibration adapter must be installed on the instrument. Testing and calibration with an AutoRAE 2 must be performed using demand-flow regulators. A calibration adapter must not be used. Teflon tubing must be used to test or calibrate the PID sensor. Follow the steps described here to perform a manual bump test:

1. Turn on your MultiRAE by pressing and holding [MODE] (the middle button) and allow the instrument to boot up fully until the main measurement screen with sensor names and readings is shown.

IMPORTANT!

Make sure all of the instrument's sensors have warmed up before performing the bump test. The instrument will take the time to warm up the sensors prior to enabling access to bump test menus. You can tell a sensor has warmed up if you see a reading next to its name on the display. If it has not warmed up, you see three dashes ("---") next to it.

2. Enter the Bump Test menu. It is accessible either through Programming Menu/Calibration or using the following easy shortcut:

With the instrument running in Normal Mode and the main measurement screen shown, press both [Y/+] and [N/-] at the same time and hold them for 5 seconds. If all the sensors have warmed up, the Multi-Bump Test menu then appears:

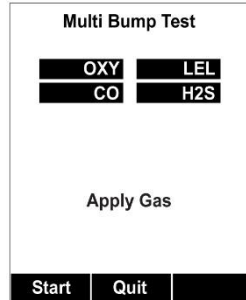

Otherwise, the menu appears after the warm-up is complete (while it is warming up, the screen indicates that you must wait for the sensors to warm up).

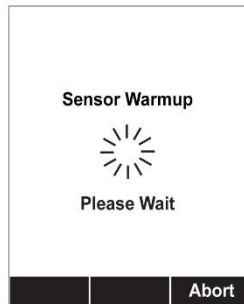

Note: If you do not apply gas within a couple of minutes, the screen changes briefly to indicate gas has not been applied, and then the instrument returns to its normal reading screen.

3. Install the calibration adapter on the MultiRAE and connect it to the calibration gas. Turn on the gas to initiate flow.
4. Press [Y/+] to start the bump test. While the bump test is being performed, the readings for each sensor are shown. Once the bump test completes, pass/fail test results and readings are shown for each sensor.

Note: If a PID or other sensors are installed in the instrument require a dedicated cylinder of gas to calibrate, the instrument will prompt for calibrating such sensors at this point.

5. If a PID or other sensors installed in the instrument require a dedicated gas cylinder to calibrate, the instrument will prompt to calibrate such sensors at this point. Disconnect the gas cylinder and connect the next (for example, 100 ppm Isobutylene for a PID).
6. Press “OK” to proceed to the PID sensor test. Turn on the gas and press Start ([Y/+] button). While the bump test is being performed, PID sensor readings are shown. Once the bump test completes, pass/fail test results and readings are shown for the PID sensor.

Note: If other installed sensors require a dedicated cylinder of gas to calibrate, the instrument prompts for calibrating these sensors at this point.

IMPORTANT!

If one or more sensors fails a bump test, be sure to calibrate those sensors.

7. The bump test is now complete. Press Exit to return to the main measurement screen.
8. Now perform a manual alarms test, as described in section 11.1.

If all the alarms and all sensors have passed and no sensor is due for a calibration, the instrument is now ready for use.

Note: When a manual bump test is performed, the readings shown are in the equivalent units of the calibration gas, and not the measurement gas (if different).

11.2.4 Testing The Gamma Radiation Sensor

The gamma radiation sensor does not require user calibration. You can check it by placing a check-source on the rear of the MultiRAE equipped with a gamma sensor to check the readings. A raised dot on the rubber boot marks where the sensor is located inside the instrument.

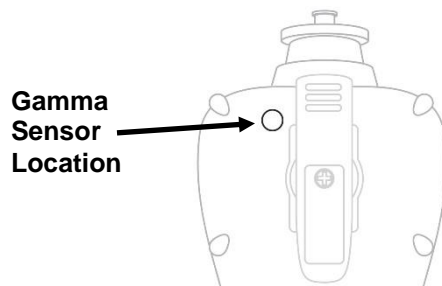

11.3 Zero/Fresh Air Calibration

This operation sets the zero point of the sensor calibration curve for clean air. It should be performed before other calibrations.

IMPORTANT!

Even though most toxic gas sensors can be zeroed in fresh air, sensors such as the CO₂ and the parts-per-billion PID sensor for volatile organic compounds (VOCs) should not be zeroed in fresh air. Both CO₂ gas and VOCs are normally present in ambient air, so zeroing these sensors in ambient air will not allow for a true zero to be set for such sensors. The CO₂ sensor should be zeroed in 99.9% nitrogen and the parts-per-billion PID sensor should be zeroed with ambient air using a charcoal filter or a VOC zeroing tube.

Note: If you use a zero air or other gas cylinder, you must use the MultiRAE Calibration Adapter. A calibration adapter is not necessary for calibration in fresh air.

11.3.1 Zero Calibration For A CO₂ Sensor

IMPORTANT! If your MultiRAE is equipped with a CO₂ sensor, it must be zero calibrated using 100% Nitrogen (N₂), which is inert, instead of fresh air or zero air.

11.3.2 Zero Calibration For Parts-Per-Billion (ppb) Sensor

IMPORTANT! The parts-per-billion PID sensor for volatile organic compounds (VOCs) should not be zeroed in fresh air. VOCs are normally present in ambient air, so zeroing the sensor in ambient air will not allow for a true zero to be set. The parts-per-billion PID sensor should be zeroed with ambient air using a charcoal filter or a VOC zeroing tube.

11.3.3 Fresh Air Calibration

This procedure determines zero points of most sensors. The MultiRAE should be zero-calibrated in clean air with 20.9% oxygen or with a cylinder of clean zero air.

At the Calibration menu, select “Fresh Air” by pressing [Y/+] once to enter fresh air calibration.

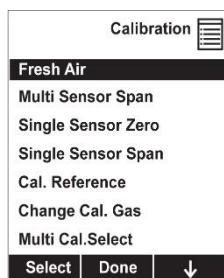

After a timer countdown, the zero calibration is done. The LCD displays the sensor names and tells you whether each calibration passed or failed, followed by the sensor readings.

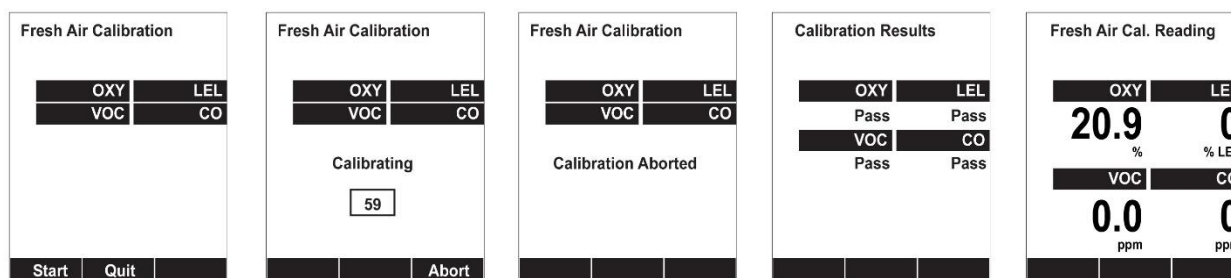

Note: You can abort the calibration at any time during the countdown by pressing [N/-].

11.3.4 Single-Sensor Zero Calibration

Select the sensor and then start the calibration by pressing [Y/+]. You can abort the procedure anytime by pressing [N/-].

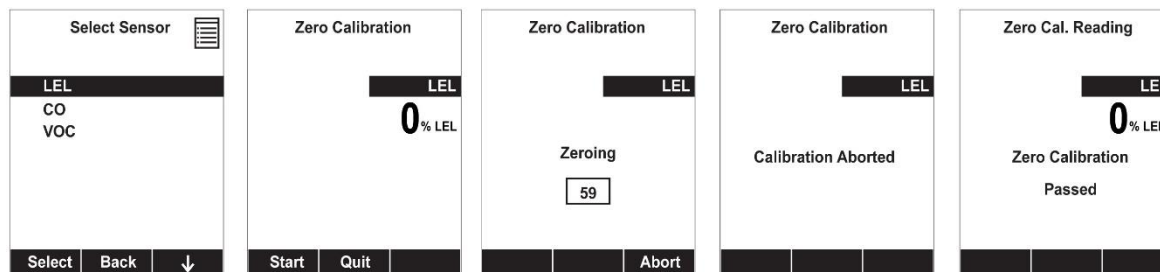

11.4 Span Calibration

This procedure determines the second point of the sensor calibration curve for the sensor.

Note: When a manual calibration is performed, the readings shown are in the equivalent units of the calibration gas, and not the measurement gas.

11.5 Three-Point Calibration For Enhanced Linearity With Extended-Range And ppb PID Sensors

For better linearity at higher concentrations when a MultiRAE is equipped with a PID sensor, a 3-point calibration can be performed.

IMPORTANT!

Three-point calibration is disabled by default, but can be enabled using ProRAE Studio II Instrument Configuration and Data Management software on MultiRAE and MultiRAE Pro instruments with 10.6eV PID sensors, including high-range ppm and ppb PID sensors. The MultiRAE Lite PID sensor does not support three-point calibration.

Default calibration gas settings for MultiRAE PID sensors are as follows:

Sensor	Specifications	Zero	Span	Span 2 (Third calibration point, if enabled)
MultiRAE Pro parts-per-billion (ppb) PID	0 to 2,000 ppm range, 10 ppb resolution	With a charcoal filter or VOC zeroing tube	10 ppm Isobutylene	100 ppm Isobutylene
MultiRAE extended-range ppm PID	0 to 5,000 ppm range, 0.1 ppm resolution	Fresh air or dry air	100 ppm Isobutylene	1,000 ppm Isobutylene
MultiRAE Lite PID	0 to 1,000 ppm range, 1 ppm resolution	Fresh air or dry air	100 ppm Isobutylene	Not supported
MultiRAE Benzene 9.8eV lamp	0 to 2,000 ppm range, 1 ppm resolution	Fresh air or dry air	100 ppm Isobutylene 5 ppm Benzene	Not supported

11.5.1 Enabling 3-Point Calibration Via ProRAE Studio II

The MultiRAE must be connected to a PC through the supplied Desktop Cradle, Travel Charger, or AutoRAE 2 and must be in the PC or AutoRAE 2 communications mode.

1. Start up the ProRAE Studio II software, enter a password, and detect the instrument following the directions provided in the ProRAE Studio II User's Manual.
2. Click "Setup" to download the MultiRAE's current configuration information.
3. Click "Sensor Summary" to show the list of installed sensors.

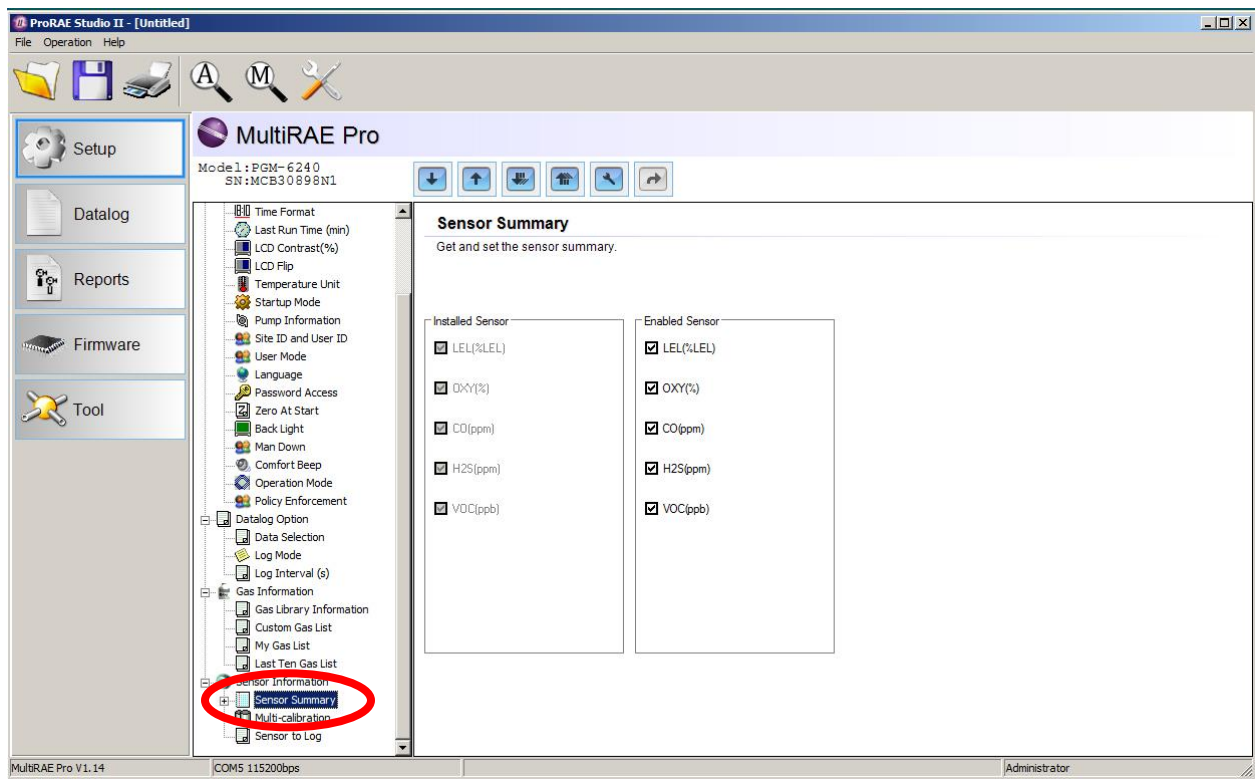

- Click “VOC(ppm)” or “VOC(ppb)” to get and set sensor parameters.

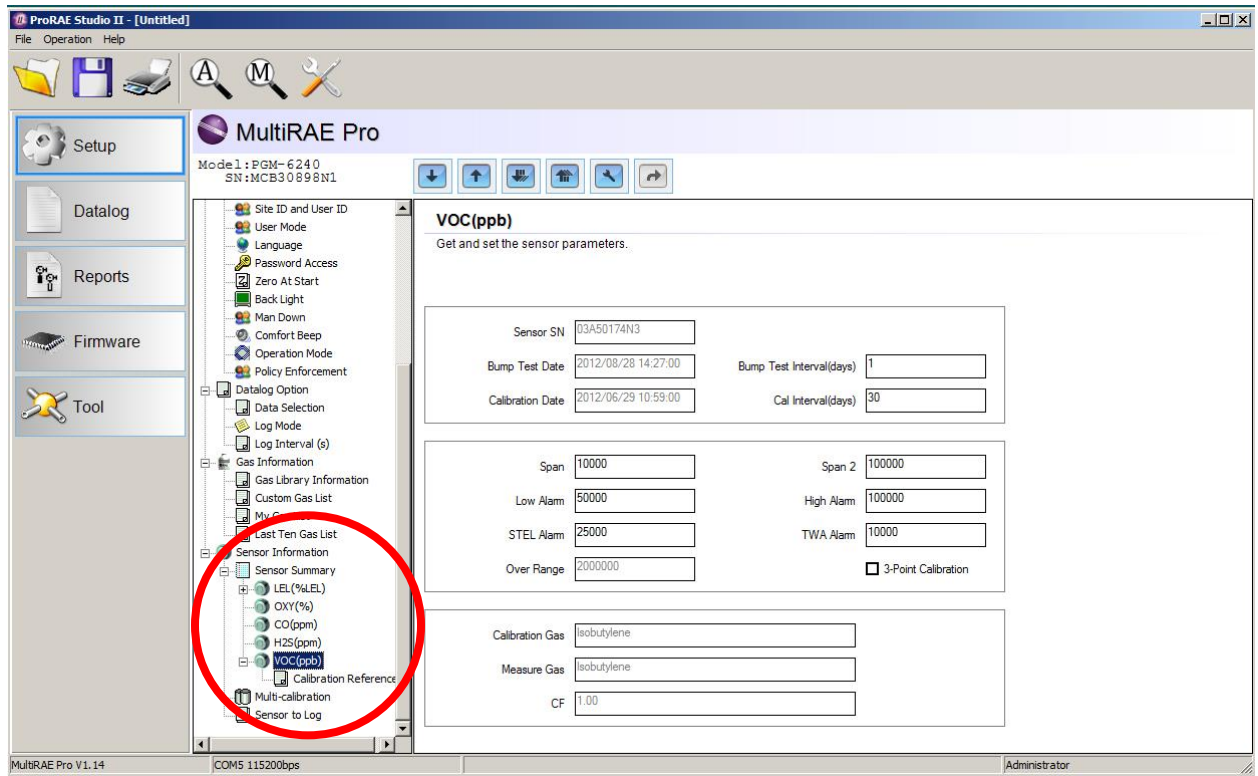

- Click 3-Point Calibration (the check mark should now be showing).

Span 2

High Alarm

TWA Alarm

3-Point Calibration

- Click the “Upload all settings to the instrument” icon. You will be asked whether you want to upload all configurations to the instrument. Click “Yes.”
- When you are done, quit ProRAE Studio II and then press [Y/+] on the MultiRAE to exit the PC communications mode. The instrument returns to operating in Normal mode.

11.5.2 Multi-Sensor Span Calibration

This lets you perform a span calibration on multiple sensors simultaneously. It requires using the appropriate span gas and that the concentration labeled on the gas cylinder matches the concentration programmed in the MultiRAE.

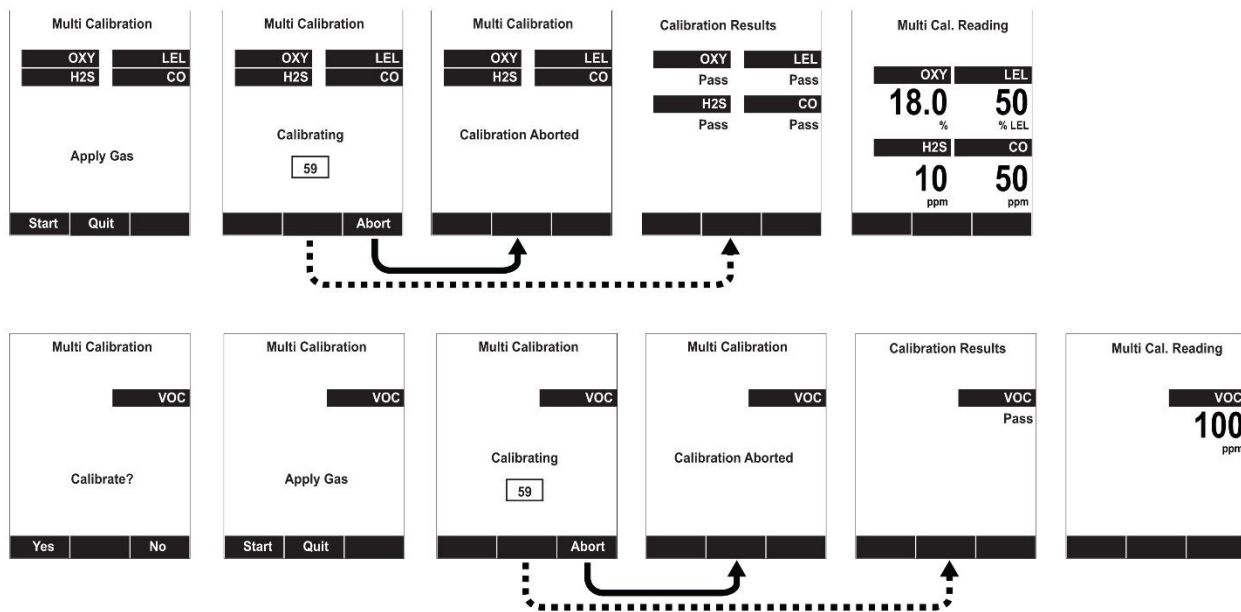

For a multi-sensor span calibration, a constant-flow regulator producing 0.5 to 1 liters per minute should be used, and the calibration adapter must be installed on the instrument. Testing and calibration with an AutoRAE 2 must be performed using demand-flow regulators. A calibration adapter must not be used. Teflon tubing must be used to test or calibrate the PID sensor. Follow the steps described here to perform a multi-sensor span calibration:

1. Attach the calibration adapter and connect gas to the MultiRAE.
2. Start the flow of gas and then either press [Y/+] to begin calibration or wait for calibration to start automatically once the sensor "senses" the gas. A countdown screen is shown. You can abort the calibration at any time during the countdown by pressing [N/-].

If the calibration reaches its conclusion, it shows the sensor names and tells you whether the calibration passed or failed, followed by the sensor readings.

Note: If there are other sensors to be calibrated at this stage, the screens will guide you through the process.

11.5.3 Single-Sensor Span Calibration

To perform span calibration of an individual sensor, follow these steps:

1. At the Calibration Menu, select “Single Sensor Span.”
2. Select a sensor from the list.
3. Connect the calibration adapter and connect it to a source of calibration gas.
4. Verify that the displayed calibration value meets the concentration label on the gas cylinder.
5. Start the flow of calibration gas.



6. Press [Y/+] to start calibrating. You can abort the calibration at any time during the countdown by pressing [N/-].

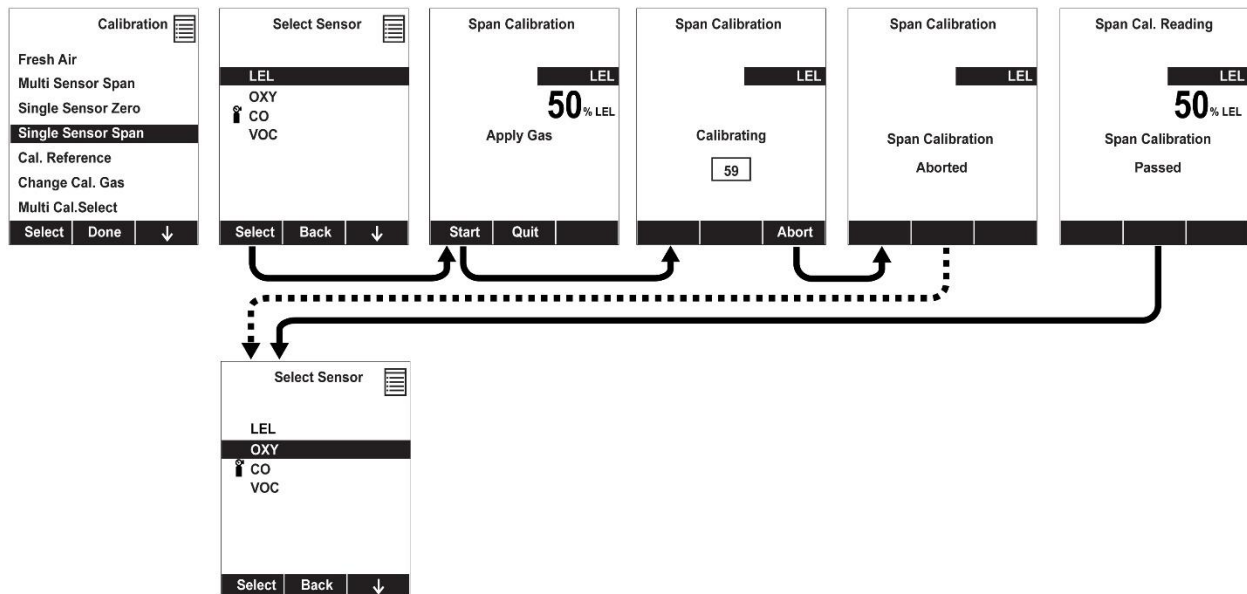

After a timer countdown, the span calibration is done. The LCD will display whether the calibration was successful and the reading for that calibration gas.

Note: If the sensor calibration fails, try again. If calibration fails repeatedly, turn off the instrument and then replace the sensor.

WARNING: Do not replace sensors in hazardous locations.

12 MultiRAE Pro Normal & Gamma Operation

MultiRAE Pro monitors equipped with a gamma radiation sensor in addition to one or more sensors for detecting chemical threats can operate in two different measurement modes:

- **Normal mode**, in which the instrument monitors for both chemical threats and radiation simultaneously
- **Radiation-only mode**, in which the instrument continuously monitors for gamma radiation and does not monitor for chemical threats

The specifics of each operating mode are described in the following sections.

12.1 Normal Mode For Simultaneous Radiation & Gaseous Threat Measurements

Normal mode is the default mode of MultiRAE Pro's operation. It is only available on MultiRAE Pro monitors equipped with a gamma radiation sensor, provided the gamma sensor is enabled. The minimum instrument firmware requirements for the gamma sensor are:

- Application firmware: v.1.16 or higher
- Sensor firmware: v.1.06 or higher

When the monitor is turned on, it boots up in normal mode to monitor for both gamma radiation and gaseous threats. Measurements are done continuously.

12.2 Gamma Radiation-Only Measurement Mode

When the instrument is in gamma-only mode, gas sensors are not shown on the display and gas measurements are not taken. The pump remains off and gamma radiation is measured all the time.

WARNING

Toxic and combustible gases cannot be detected by the MultiRAE when it is operated in gamma-only mode.

12.2.1 Activating Gamma-Only Measurement Mode

To activate gamma-only measurement mode:

1. Press [N/-] when the instrument is running in normal (multi-threat) mode:

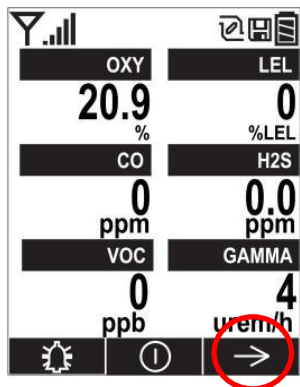

2. Press [Y/+] when the following screen appears:

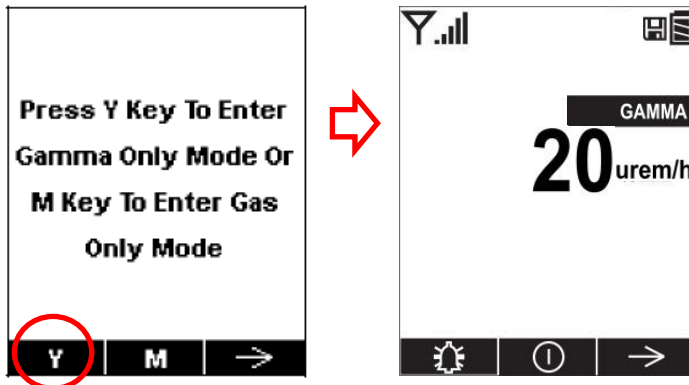

12.2.2 Exiting Gamma-Only Measurement Mode

To exit gamma-only mode and either switch back to normal mode (where both gamma radiation and gaseous threats are measured) or to gas-only mode:

1. Press [N/-] when the instrument is running in gamma-only mode:



2. The following screen appears:

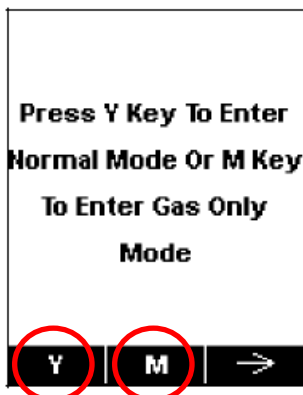

- Press [Y/+] to enter normal (multi-threat) mode.
- Press [MODE] to enter gas-only mode.

Notes:

- If the monitor runs in gamma-only mode for over 20 minutes, TWA is not calculated for gas sensors.
- STEL is reset for gas sensors when the instrument exits gamma-only mode.

13 Datalog Transfer, Monitor Configuration, and Firmware Upgrades Via Computer

Datalogs can be downloaded from the MultiRAE to a computer, and firmware updates can be uploaded to the MultiRAE via the USB port on the Travel Charger, Desktop Cradle, or AutoRAE 2. Use the included Mini B USB (5-pin)-to-USB cable to connect the Travel Charger or Desktop Cradle to a computer running ProRAE Studio II or a USB A to USB B cable to connect the AutoRAE 2.

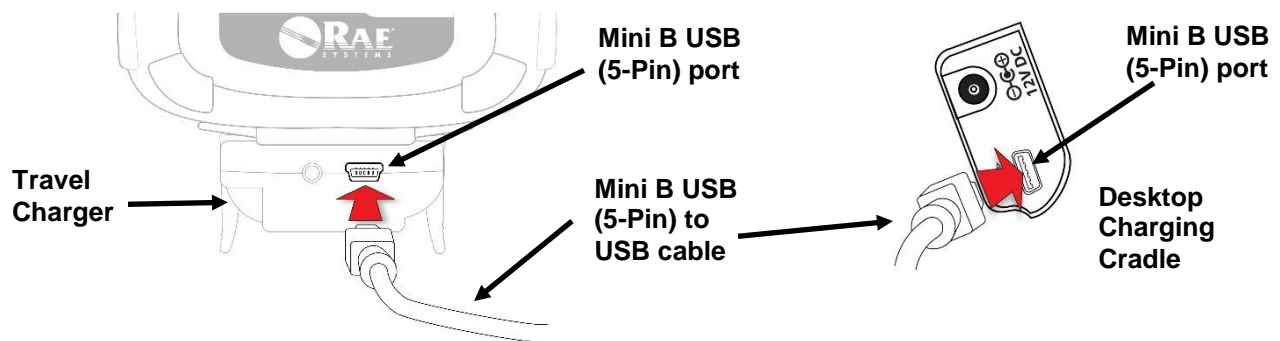

13.1 Downloading Datalogs And Performing PC-Based Instrument Configuration And Firmware Upgrades

The MultiRAE communicates with a PC running ProRAE Studio II Instrument Configuration and Data Management software to download datalogs, configure the instrument, or upgrade the instrument's firmware.

Note: The most recent version of ProRAE Studio II Instrument Configuration and Data Management software is available for a free-of-charge download at: <http://www.raesystems.com/downloads/product-software>

The MultiRAE must be connected to a PC through the supplied Desktop Cradle, Travel Charger, or AutoRAE 2 and must be in the PC or AutoRAE 2 communications mode.

13.1.1 Desktop Cradle or Travel Charger

1. Use the supplied PC Communications Cable (USB to mini-USB cable) to connect the Desktop Cradle or Travel Charger to a PC.
2. Turn on the MultiRAE. Make sure it is running in Normal mode (with the main measurement screen showing).
3. Insert the MultiRAE in the Desktop Cradle or connect it to the Travel Charger.
4. Activate the PC communications mode on the MultiRAE by pressing [N/-] repeatedly, starting from the main measurement screen until you reach the "Communicate With Computer?" screen.
5. Press [Y/+]. Measurement and datalogging stop, and the instrument is now ready to communicate with the PC. The display now says "Ready To Communicate With Computer."
6. Start up the ProRAE Studio II software, enter a password, and detect the instrument following the directions provided in the ProRAE Studio II User's Guide.
7. Follow the instructions in the ProRAE Studio II User's Guide to download the datalog, configure the instrument settings, or update the MultiRAE's firmware.
8. When you are done, press [Y/+] to exit the PC communications mode on the MultiRAE. The instrument returns to operating in Normal mode.

13.1.2 AutoRAE 2

1. Follow the instructions in the AutoRAE 2 User's Guide to connect the AutoRAE 2 and the PC using the included cable.
2. Make sure the monitor is either turned off or is in AutoRAE 2 Communications Mode.
3. Place the instrument into the cradle face-down, making sure that it is aligned correctly with the contacts on the AutoRAE 2 Cradle's charging port. There are two alignment points on one side and one alignment point on the other side, designed to mate with matching points on the bottom of the MultiRAE.
4. Press in on the capture mechanism to lock the MultiRAE in place.
5. Start up the ProRAE Studio II software, enter a password, and detect the instrument following the directions provided in the ProRAE Studio II User's Guide.
6. Follow the instructions in the ProRAE Studio II User's Guide to download the datalog, configure the instrument settings, or to update the MultiRAE's firmware.
7. When you are done, press [Y/+] to exit the AutoRAE 2 Communications Mode on the MultiRAE. The instrument returns to operating in Normal mode.

13.1.3 Upgrading Firmware – Two Steps

Because the MutliRAE has two separate applications (main board application and sensor module application), ProRAE Studio II version 1.11.2 and higher have a single button to upgrade firmware for the main application and the sensor.

Follow these steps:

1. Connect with MultiRAE and switch to Firmware page.

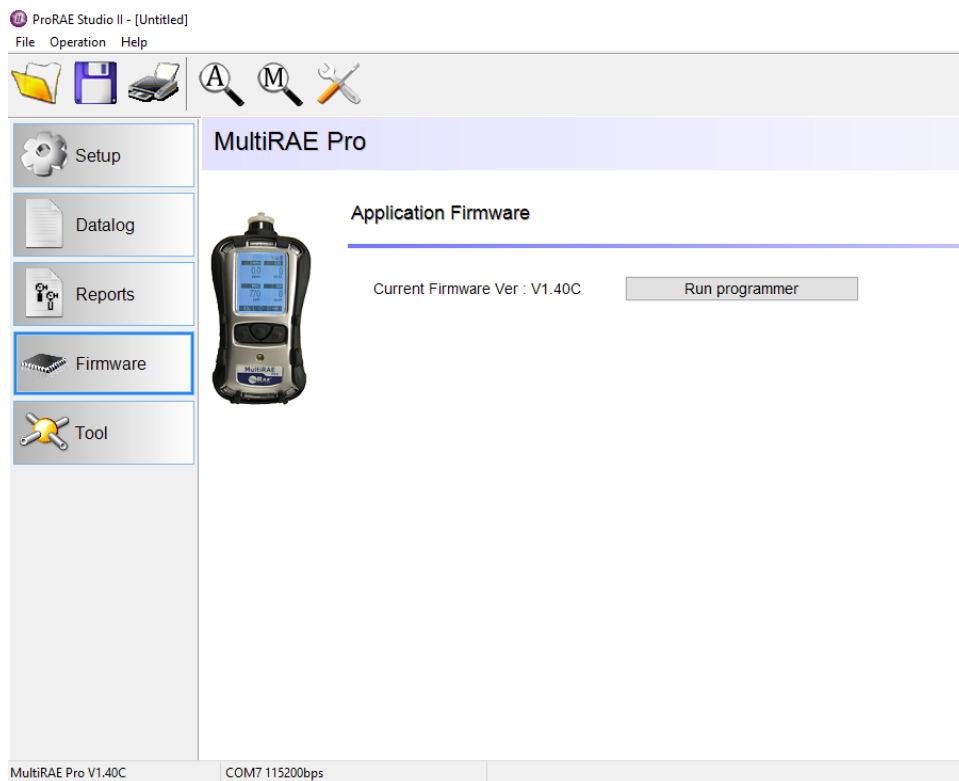

- Click “Run programmer” to start RAE Programmer 4000. Open the firmware package for the MultiRAE Sensor, and click “Start” to upgrade the sensor module firmware.

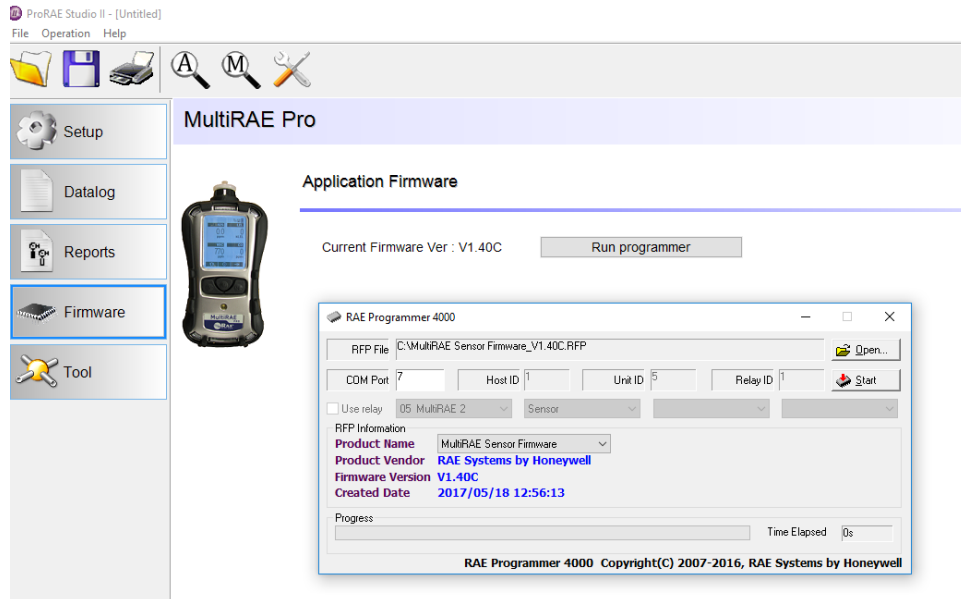

- After the firmware upgrade for the sensor module is complete, open the firmware package for the MultiRAE Application and click “Start” to upgrade the MultiRAE Application firmware.

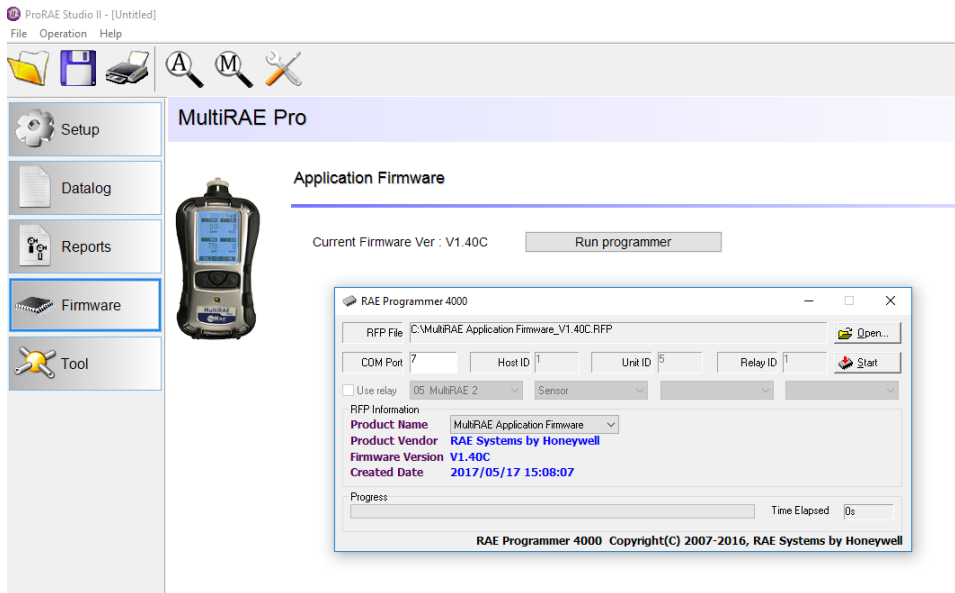

Notes:

- You must upgrade the sensor module firmware first, and then the application firmware.
- “Application Firmware” means all applications for the instrument.

14 Maintenance

The MultiRAE requires little maintenance, aside from replacing sensors, the filter, and the battery. If the instrument is equipped with a pump, it may need replacement, as well. If the instrument has a PID, then the PID sensor lamp and sensor electrode panel may require periodic cleaning.

14.1 Removing/Installing The Rubber Boot

In order to open the MultiRAE, it is necessary to remove the belt clip and the rubber boot. Note that there are two hex screws on the bottom rear side that secure the boot.

1. Remove the belt clip by unscrewing the Philips screw (pumped version only).
2. Remove the two hex screws located below the battery area.
3. Pull the bottom of the boot back over the rear side of the instrument.
4. Carefully slide the boot upward, and slide it over the D-ring and clamp.

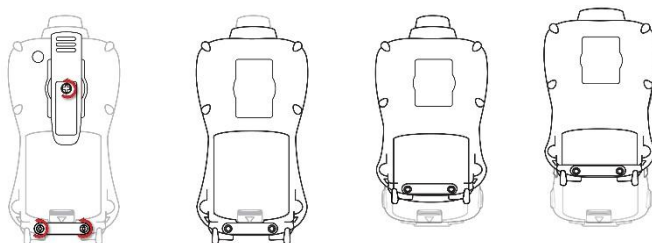

14.2 Replacing The Filter(s)

Pumped Version

If a filter is dirty or clogged, remove it by unscrewing it from the black gas inlet adapter. Discard it and replace it with a new filter. Perform a pump stall test to make sure the inlet and the external filter are installed properly so that there are no leaks in the system.



Diffusion Version

If the filters appear dirty, remove the sensor compartment cover to access them (this requires removing the rubber boot first).

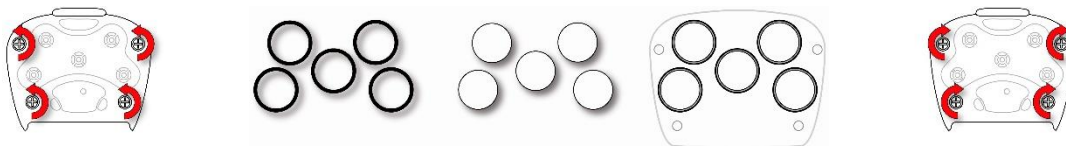

Remove the four screws holding the sensor compartment cover in place.

Remove the O-rings and then remove the filters. Replace them with new filters (press around the perimeter of each to ensure that the adhesive holds them firmly) and install the O-rings in their proper locations. O-rings may need to be replaced as well if they appear worn down, cracked, or dirty

Replace the sensor compartment cover and tighten the four screws.

14.3 Replacing The Gas Inlet Adapter (Pumped Versions Only)

When you remove the black gas inlet adapter, unscrew it in the same manner as the external filter. When replacing it, make sure that the arrow on the front points to the triangle on the rubber boot. Perform a pump stall test to make sure the inlet and the external filter are installed properly so that there are no leaks in the system.

Match arrow on nozzle to triangle on rubber boot

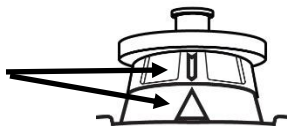

14.4 Removing/Cleaning/Replacing Sensor Modules

WARNING! Do not replace sensors in hazardous locations.

All sensors are located inside the sensor compartment in the upper half of the MultiRAE. They are accessed by removing the cover that is held on by four screws.

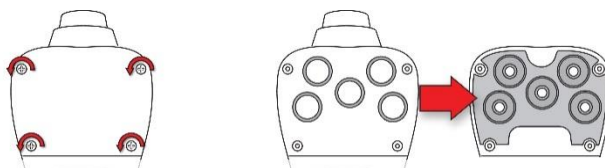

1. Turn off the instrument.
2. Remove the four screws holding the sensor compartment.
3. Remove the cover. The sensors are plugged into the slots.
4. Gently lift out the desired sensor module with your fingers.
5. Install the replacement sensor. It can only go into its slot one way. The connector inside the MultiRAE and the indexing guides are good visual indicators of how to set the sensor into position. Make sure the indexing keys are aligned and that the sensor is seated firmly.

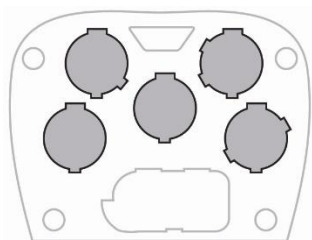

Match index keys on sensor module with socket

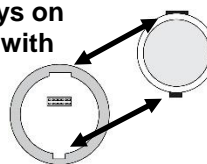

Sensor indexing key

WARNING!

If you are removing a sensor and not replacing it, the slot cannot be left empty. A MultiRAE “dummy” sensor must be installed in such slot.

14.5 Removing/Cleaning/Replacing A PID (Pumped Versions Only)

Note: If you need to access a PID for cleaning or replacement, you must remove the rubber boot and belt clip first.

1. Turn off the instrument.
2. Remove the four screws holding the MultiRAE sensor compartment cover in place.
3. Remove the cover to expose the sensors.

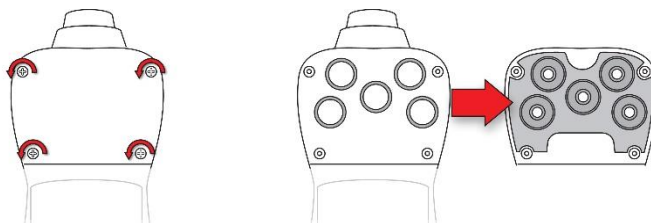

4. Gently lift out the PID module with your fingers.
5. If the module requires replacement (for example, because the lamp does not illuminate, or the sensor repeatedly fails calibrations), place a new module into the slot, being careful to match the indexing keys. The sensor can only go into its slot one way.

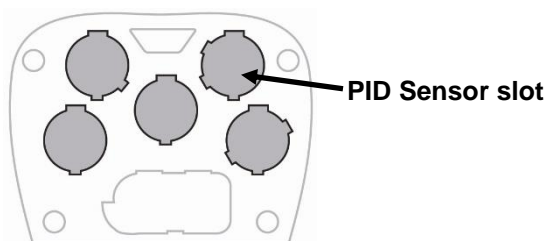

6. If you want to open the sensor module to inspect and clean the lamp and sensor electrode panel, you must use the special tool (part number G02-0306-003, package of three). Its “C”-shaped end has small “teeth” inside. Slide the tool so that the teeth slip into the notch between the module’s cap and body:

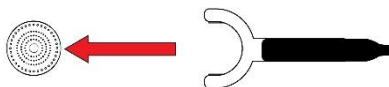

7. Gently pry up the cap using a rocking motion:

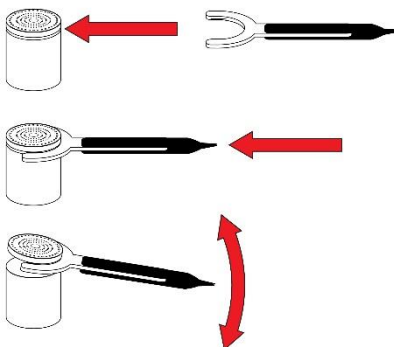

8. Once the cap is removed, set it aside.

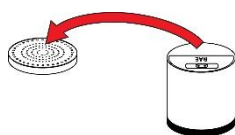

9. Now lift the sensor electrode panel from the module:

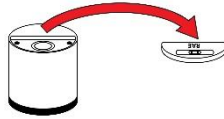

10. Clean the sensor electrode panel (crystal) in a solution of isopropanol or methanol lamp cleaner (included, along with cleaning swabs, in a PID Lamp Cleaning Kit, sold separately), and allow it to dry.

11. Clean the lamp's window with a cleaning swab dipped in isopropanol or methanol lamp cleaner, and allow it to dry. Do not touch the lamp window with your fingers, as the residual oils will affect its performance and shorten its life.

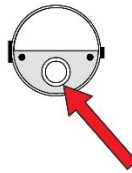

12. Inspect the electrical contacts. Clean them with a swab dipped in lamp cleaner if they appear to need cleaning:

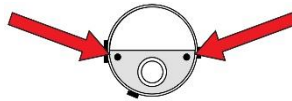

13. Reassemble the sensor module by placing the sensor electrode panel back in place and firmly pressing the cap back onto the top.

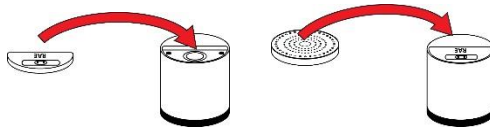

14. Place the sensor module back into the MultiRAE. Make sure the index points are aligned (it can only go in one way).

15. Reinstall the rear cover.

16. Tighten all four screws.

Note: Always calibrate the MultiRAE after replacing the sensor module.

14.6 Replacing The Pump

If your MultiRAE has a pump and it requires replacement, follow these steps. Make sure the rubber boot and the battery are removed before proceeding.

1. Remove the sensor compartment cover.



Turn it upside down and set it on a soft flat surface.

2. The pump is to the sensor compartment cover by a metal bracket and two Philips screws.
Remove the two screws.
3. Lift off the metal bracket.
4. Pressing down on the gas plate with one hand, disconnect the pump from internal tubing by gently pulling it out. It has an inlet and outlet that are held in the two holes with rubber gaskets to the left of the pump cavity.

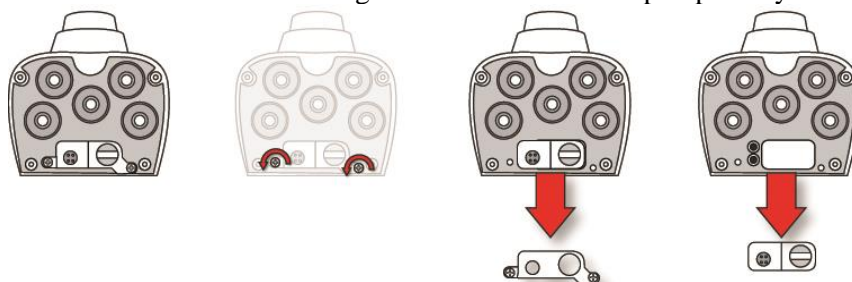

5. Press a new pump into place (a small amount of wiggling helps), making sure that both the inlet and outlet from the pump go into the two holes.
6. Place the metal bracket over the pump.
7. Insert and tighten the two screws that attach the bracket to the housing.
8. Replace the cover.
9. Turn on the instrument and check for proper pump operation.

15 Alarms Overview

The MultiRAE provides an unmistakable five-way alarm notification system that combines local alarms on the device with real-time remote wireless alarm notification (if the instrument is equipped with the optional wireless functionality) to take worker safety to the next level. Local alarms include audible buzzer alarm, visible alarm via bright LED lights, vibration alarm, and an alarm notification on the display. These can be selectively turned on or off.

Note: The vibration alarm is automatically disabled whenever the instrument is run on alkaline batteries.

15.1 Alarm Signals

During each measurement period, the gas concentration and radiation levels are compared with the programmed alarm limits for Low, High, TWA, STEL, and other alarms, as applicable. If the concentration exceeds any of the preset limits, the alarms are activated immediately to warn both the MultiRAE user and a remote safety officer (if wireless is enabled) of the alarm condition. In addition to gas and radiation alarms, Man Down and other alarms are available.

Furthermore, the MultiRAE alarms if one or more of the following conditions occurs: battery voltage low, pump blocked, PID lamp failed, etc.

When the low battery alarm occurs, there may be approximately 10 minutes of operating time remaining. In this case, it is recommended that you promptly change or charge the battery in a non-hazardous location.

15.2 Changing The Alarm Mode

Your choices are Auto Reset and Latched. A latched alarm stays on until you acknowledge the alarm by pressing a button. An auto-reset alarm turns off when the condition that set off the alarm is no longer present (for instance, a high H₂S reading that exceeds the preset threshold and triggers an alarm, but then lowers below that threshold, turning the alarm off).

1. Enter the Alarm Mode sub-menu of the Alarms section under the Programming Menu.
2. Select Auto Reset or Latched by pressing [N/-] to select, and [Y/+] to confirm the choice.
3. Press [Y/+] to save your selection.

15.3 Alarm Signal Summary

15.3.1 Hygiene Mode

Alarm Type	Buzzer & LED	Display	Vibration	Reading	Backlight	Priority
Super Alarm	4 beeps/sec	“Super Alarm” screen	400ms	-	On	Highest
Man Down Alarm	3 beeps/sec	“Man Down Alarm” screen	400ms	-	On	
Man Down Warning	2 beeps/sec	“Are you OK” screen	400ms	-	On	
Fail	3 beeps/sec	“Lamp” at PID location “Off” at LEL location	400ms	Blinking reading	On	
Pump	3 beeps/sec	Blinking pump symbol	400ms	Reading	On	
Max	3 beeps/sec	“Max” at sensor location	400ms	Blinking reading	On	
Over Range	3 beeps/sec	“Over” at sensor location	400ms	Blinking 9999	On	
High	3 beeps/sec	“High” at sensor location	400ms	Reading	On	
Low	2 beeps/sec	“Low” at sensor location	400ms	Reading	On	
Negative	1 beep/sec	“Neg” at sensor location	400ms	0	On	
STEL	1 beep/sec	“STEL” at sensor location	400ms	Reading	On	
TWA	1 beep/sec	“TWA” at sensor location	400ms	Reading	On	
Calibration Fail	1 beep/sec	“Cal” at sensor location	400ms	Reading	On	
Bump Fail	1 beep/sec	“Bump” at sensor location	400ms	Reading	On	
Datalog Full	1 beep/sec	Blinking datalog symbol	400ms	Reading	On	
Calibration Required	-	“Full” Bottle symbol	-	Reading	-	
Bump Required	-	“Empty” Bottle symbol	-	Reading	-	
Battery	1 beep/min	Blinking battery symbol	400ms	Reading	Stays as is	
Nwk Lost	1 beep/min	Blinking RF offline symbol	400ms	Reading	On	
Nwk Joined	1 beep	RF symbol with RSSI	400ms	Reading	On	
Comfort Beep	1 beep/min no LED flash	-	-	Reading	-	

Notes

“Negative” means that the true sensor reading is below zero, even though a zero reading is shown for the sensor.

“Nwk Lost” means “Network Lost.” This indicates that the MultiRAE has lost wireless connectivity with its network.

“Nwk Joined” means that the MultiRAE has joined a wireless network.

15.3.2 Search Mode

Alarm Type		Buzzer & LED	Display	Vibration	Reading	Backlight	Priority
Super Alarm		4 beeps/sec	“Super Alarm” screen	400ms	-	On	Highest
Man Down Alarm		3 beeps/sec	“Man Down Alarm” screen	400ms	-	On	↑ ↓
Man Down Warning		2 beeps/sec	“Are You OK?” screen	400ms	-	On	
Fail		3 beeps/sec	“Lamp” at PID location “Off” at LEL location	400ms	Blinking reading	On	
Pump		3 beeps/sec	Blinking pump symbol	400ms	Reading	On	
Max		3 beeps/sec	“Max” at sensor location	400ms	Blinking reading	On	
Over Range		3 beeps/sec	“Over” at sensor location	400ms	Blinking 9999	On	
Geiger Counter-style Alarm	G7 (>High)	7 beeps(30ms)/sec	No change	400ms	Reading	On	
	G6	6 beeps(40ms)/sec					
	G5	5 beeps(50ms)/sec					
	G4	4 beeps(60ms)/sec					
	G3	3 beeps(70ms)/sec					
	G2	2 beeps(80ms)/sec					
	G1 (>Low)	1 beep(90ms)/sec					
Negative		1 beep/sec	“Neg” at sensor location	400ms	0	On	
STEL		1 beep/sec	“STEL” at sensor location	400ms	Reading	On	
TWA		1 beep/sec	“TWA” at sensor location	400ms	Reading	On	
Calibration Fail		1 beep/sec	“Cal” at sensor location	400ms	Reading	On	
Bump Fail		1 beep/sec	“Bump” at sensor location	400ms	Reading	On	
Datalog Full		1 beep/sec	Blinking datalog symbol	400ms	Reading	On	
Calibration Required		-	“Full” bottle symbol	-	Reading	-	
Bump Required		-	“Empty” bottle symbol	-	Reading	-	
Battery		1 beep/min	Blinking battery symbol	400ms	Reading	Stays as is	
Nwk Lost		1 beep/min	Blinking RF offline symbol	400ms	Reading	On	
Nwk Joined		1 beep	RF symbol with RSSI	400ms	Reading	On	
Comfort Beep		1 beep/min No LED flashing	-	-	Reading	-	Lowest

15.3.3 General Alarms

Message	Condition	Alarm Indications
HIGH	Gas exceeds “High Alarm” limit	3 beeps/flashes per second
OVR	Gas exceeds sensor’s measurement range	3 beeps/flashes per second
MAX	Gas exceeds electronic circuit’s maximum range	3 beeps/flashes per second
LOW	Gas exceeds “Low Alarm” limit*	2 beeps/flashes per second
TWA	Gas exceeds “TWA” limit	1 Beep/flash per second
STEL	Gas exceeds “STEL” limit	1 Beep/flash per second
Crossed pump icon flashes	Inlet blocked or pump failure	3 beeps/flashes per second
“Lamp” flashes	PID lamp failure	3 beeps/flashes per second
Empty battery icon flashes	Low battery	1 flash, 1 beep per minute
CAL	Calibration failed, or needs calibration	1 beep/flash per second
NEG	True sensor reading is below zero, even though a zero reading is shown for the sensor.	1 beep/flash per second

* For oxygen, “low alarm limit” means a concentration is lower than the low alarm limit.

16 Troubleshooting

Problem	Possible Reasons & Solutions
Cannot turn on power after charging the battery	<p>Reasons: Defective charging circuit. Defective battery.</p> <p>Solutions: Replace battery or charger. Try another charge of battery.</p>
Lost password	<p>Solutions: Call Technical Support at +1 408-952-8461 or toll-free at +1 888-723-4800</p>
Buzzer, LED lights, and vibration motor inoperative	<p>Reasons: Buzzer and/or other alarms disabled. Bad buzzer, LED lights, PCB, or vibration motor(s).</p> <p>Solutions: Check under “Alarm Settings” in Programming Mode that buzzer and/or other alarms are not turned off. Call authorized service center.</p>
“Lamp” message when power on. Lamp alarm.	<p>Reasons: Low ion concentration inside PID lamp especially in cold environment when first powered on. Defective PID lamp or defective circuit.</p> <p>Solutions: Turn the unit off and back on. Replace UV lamp.</p>
Pump failed message. Pump alarm.	<p>Reasons: Inlet probe blocked. Direct connection to a gas outlet while the gas valve is turned off. Water trap filter sucks in water. Water trap filter too dirty. Water condensed along the inlet probe. Bad pump or pump circuit.</p> <p>Solutions: Remove the blocking objects and then press [Y/+] key to reset the pump alarm. Replace contaminated water trap filter. Be careful not to allow water condensation inside the unit. Replace the pump.</p>

If you need replacement parts, a list is available online:

www.raesystems.com

17 Pump Stall Threshold Adjustment

Proper setting of the pump stall threshold is necessary so that if there is an obstruction to the inlet, the pump will stop and the instrument will go into alarm. This prevents unwanted debris or liquid from entering the pump and causing disruption or damage. The MultiRAE provides two methods to set the pump stall threshold: Static and Dynamic.

Note: The Dynamic method uses an algorithm that takes external temperature into consideration for greater accuracy.

If it is necessary to set the pump stall threshold, you must enter Diagnostic Mode. Also, regardless of which method is used, when you are done setting thresholds, exit Diagnostic Mode and test the instrument before actual use.

17.1 Entering Diagnostic Mode To Set The Pump Stall Threshold

1. Start with the instrument turned off. Hold down the [Y/+] and [MODE] keys until the MultiRAE starts.
2. When you see the password screen, input your 4-digit password, and then press [MODE].
3. Once you have entered Diagnostic Mode, press [N/-] until the “Pump” screen is displayed.
4. Set the high and low threshold settings for pump stall using the instructions in this section.

17.2 Selecting The Pump Stall Threshold Method

At the Pump screen, the settings are shown, including the Pump Speed and Pump Stall Algorithm (which can be Dynamic or Static).

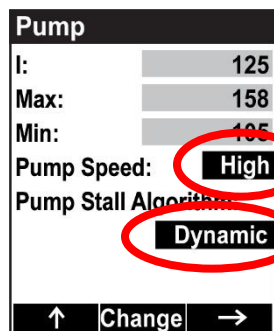

To change the Pump Speed or Pump Stall Algorithm setting:

1. Press [MODE]. Either the Pump Speed or the Pump Stall Algorithm is highlighted.
2. To change from “High” to “Low” or “Dynamic” to “Static,” press [Y/+].

Important! The Pump Speed must be set to “High” in order to access Dynamic pump stall settings.

Now follow directions to change the pump stall threshold values, using the method that matches your choice of either Dynamic or Static.

17.3 Setting Pump Stall Threshold Values – Dynamic Method

When the Dynamic pump stall threshold values are shown, you can perform calibration to set the pump stall values dynamically.

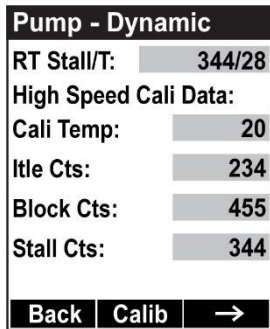

Press [MODE] to begin calibration. This screen is shown, indicating that it is ready:

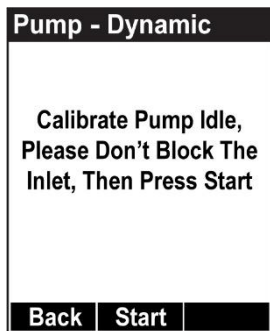

Press [MODE] to begin calibration. There is a countdown shown in the box. Press [N/-] anytime to abort the calibration.

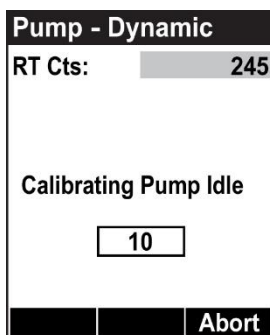

Once the countdown is finished, this message is displayed:

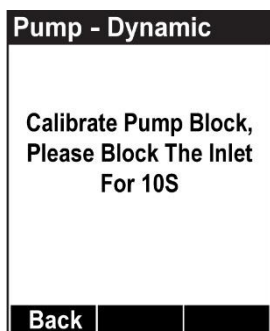

Hold your finger over the inlet, and allow the countdown to proceed. Press [N/-] anytime to abort.

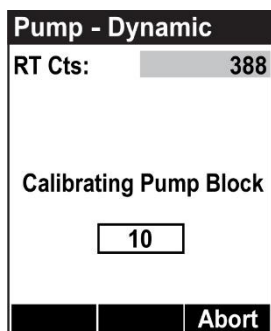

When the countdown is finished, the main Dynamic pump stall screen is shown.

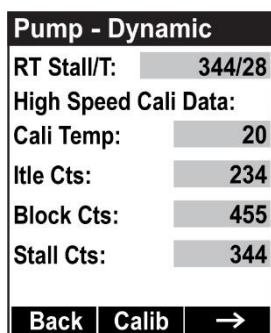

Dynamic pump stall calibration is complete. You can now exit Diagnostic Mode.

Important! When you are done setting thresholds, exit Diagnostic Mode and test the instrument before actual use.

17.4 Setting Pump Stall Threshold Values – Static Method

Use the following values for reference when using the Static method to adjust the pump stall threshold values:

	Low Speed	High Speed
Vacuum	≤ -2.5in Hg	≤ -10in Hg
Flow rate	>200 cc/min	>300 cc/min
Idle (I)	100 to 200 counts	150 to 250 counts
Block	(Block-Idle) > 100 counts	(Block-idle) > 100 counts
Stall Setting	(Idle + Block)/2	(Idle + Block)/2

17.4.1 Stall High Threshold Setting – Static Method

In Diagnostic Mode, press the [MODE] key repeatedly until the “Pump” screen is displayed. Shown are the Stall High and Stall Low values. “High” should be highlighted. Press [Y/+] to select the Stall High (high-speed) value.

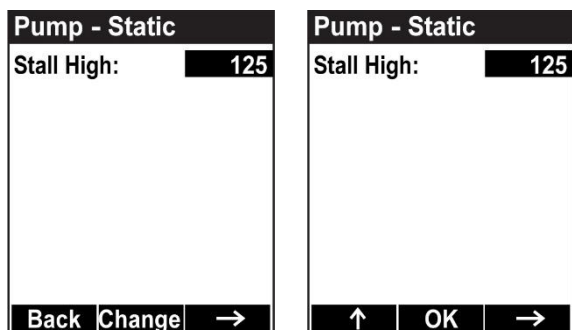

- The Idle value (shown as a value for “I”) should be 150 to 250. Record the value.
- Block the inlet, and record the value after it goes up.
- The blocked value minus the Idle (Unblocked) value should be greater than 100 counts: $(\text{Blocked value} - \text{Unblocked value}) > 100$.
- If it is greater than 100, then the pump is working correctly and tubing leading from the inlet is not leaking.
- To set the Stall High value, first add the Blocked and Unblocked values and divide by 2: $(\text{Blocked value} + \text{Unblocked value}) / 2 = \text{correct Stall High value}$.
- Then, using the [Y/+] and [N/-] keys, set the Stall High value to this number.

17.4.2 Verifying the Stall High Setting

Exit Diagnostic Mode. In Normal Mode, with the pump at high speed, block the inlet. The pump should stall after a few seconds, sending the instrument into alarm. This tells you that the pump’s Stall Low setting is correct.

- If the gas inlet is blocked but the pump does not shut down, or the pump shuts down too easily with a slight blockage, the pump stall threshold value may be set too high or too low.
- If the pump does not stall or send the instrument into alarm, then there may be a leak in the gas inlet or the pump is weak or defective and should be replaced.

17.4.3 Stall Low Threshold Setting - Static

In Diagnostic Mode, press the [MODE] key until the “Pump” screen is displayed. Shown are the Stall High and Stall Low values. “Low” should be highlighted. Press [Y/+] to select the Stall Low (low-speed) value.

- The Idle (shown as a value for “I”) value should be 100 to 200. Record the value.
- Block the inlet, and record the value after it goes up.
- The blocked value minus the idle (unblocked) value should be greater than 100 counts: $(\text{Blocked value} - \text{Unblocked value}) > 100$
- If it is greater than 100, then the pump is working correctly and tubing leading from the inlet is not leaking.
- To set the Stall Low value, first add the blocked and unblocked values and divide by 2: $(\text{Blocked value} + \text{Unblocked value}) / 2 = \text{correct Stall Low value}$
- Then, using the [Y/+] and [N/-] keys, set the Stall Low value to this number.

17.5 Verifying the Stall Low Setting - Static

Exit Diagnostic Mode. In Normal Mode, block the inlet. The pump should stall after a few seconds, sending the instrument into alarm. This tells you that the pump's Stall Low setting is correct.

- If the gas inlet is blocked but the pump does not shut down, or the pump shuts down too easily with a slight blockage, the pump stall threshold value may be set too high or too low.
- If the pump does not stall and send the instrument into alarm, then there may be a leak in the gas inlet or the pump is weak or defective and should be replaced.

Important! When you are done setting thresholds, exit Diagnostic Mode and test the instrument before actual use.

18 Configuring Wi-Fi Communication (Wi-Fi-Equipped Instruments Only)

Wi-Fi on Wi-Fi-equipped instruments is designed to operate on a wireless network anchored by ProRAE Guardian monitoring software and using Wi-Fi access points. Operational distance between the instrument and the access point (wireless router) varies, depending on distance, interference, and obstacles. It uses the 802.11b/g protocol using the 2.4GHz ISM (license-free) frequency band.

Note: To ensure the best communication, it is recommended that the Wi-Fi-equipped instruments and access point not be located close to microwave ovens, cordless telephones, or Bluetooth devices.

A green LED in the lower left portion of the Wi-Fi-equipped instrument indicates whether the Wi-Fi radio module is on, and if so, whether it is associated with an access point. There are three possible states:

- LED blinks once per second: Radio module is on, but it is not associated with an access point.
- LED glows steadily: Radio module is on and is associated with an access point.
- LED is off: Radio module is off.

18.1 Setting Wi-Fi Communication Parameters In ProRAE Studio II

Wi-Fi-equipped instruments' parameters for communication must be set in ProRAE Studio II.

1. Connect Wi-Fi-equipped instrument via USB to a PC running ProRAE Studio II.
2. Place the instrument in Communications Mode.
3. From the main screen, press [N/-] until you see “Enter Communications Mode?”
4. Press [Y/+].
5. Select PC.

The message on the display should say “Ready To Communicate With Computer”.

1. Start ProRAE Studio II.
2. Log in using your Administrator's password.
3. Click the “Detect Instruments Automatically” icon.
4. When your Wi-Fi-equipped instrument is detected, click on its information and then click “Select”.
5. Click “Setup” to download the current settings from the Wi-Fi-equipped instrument. The main screen appears.
6. Find and click “Wi-Fi” in the list.



7.

Wi-Fi parameters appear in the right pane:

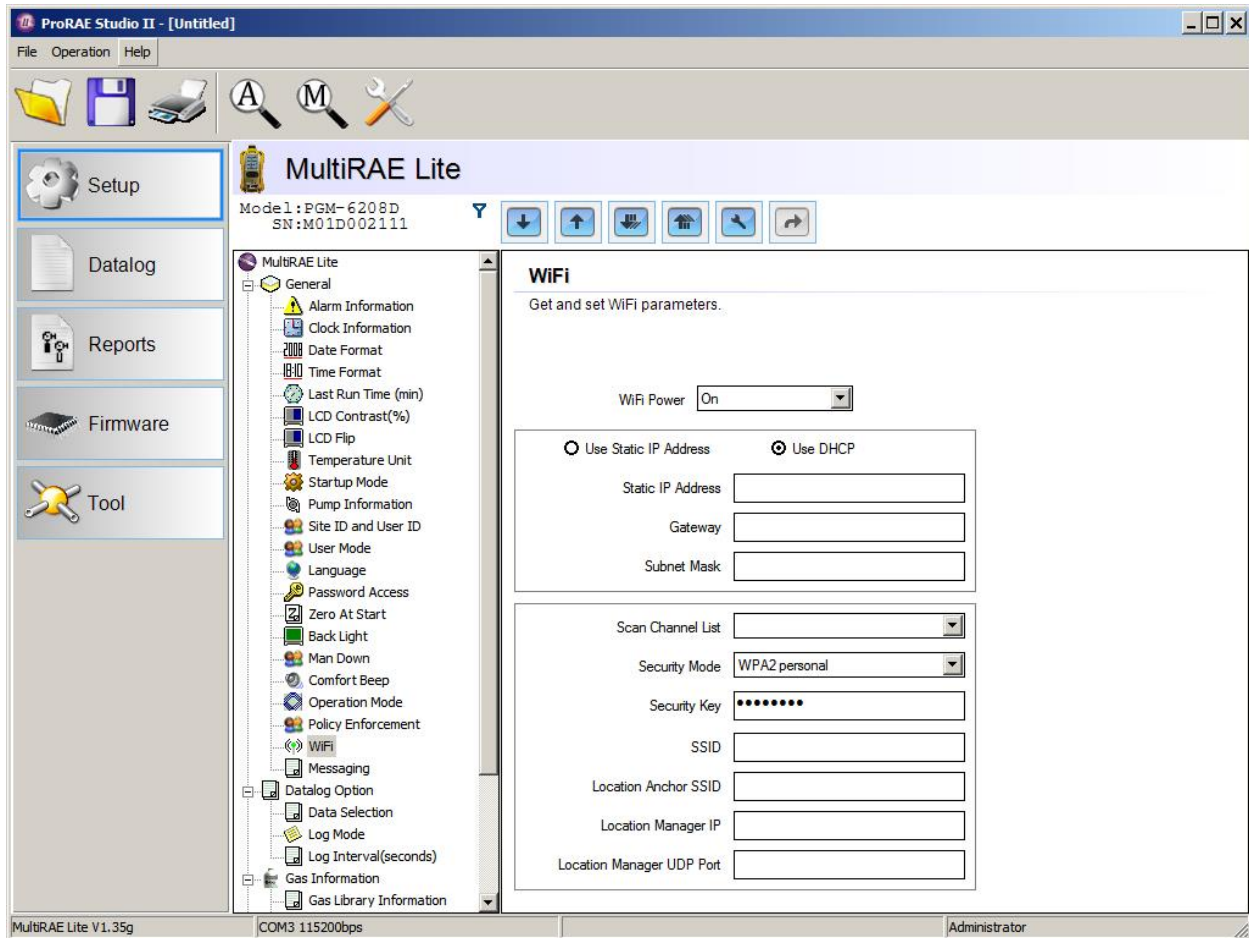

You can now change settings for the Wi-Fi-equipped instrument. When you are done, click this icon to send the new settings to the instrument:



18.1.1 Wi-Fi Power

Select either “On” or “Off” to set the default power setting for your Wi-Fi-equipped instrument.



18.1.2 Address

Select “Use Static IP Address” if you have a static IP or “Use DHCP” if your system allows dynamic hosting configuration. Check with your system administrator to determine which is appropriate for your network.

If you use a static IP address, you must provide the Static IP address, Gateway, and Subnet Mask. If you are using DHCP, you do not have to provide these, because they will be filled in automatically.

18.1.3 Channels And Security

Check with your system administrator for the settings in this section.

18.1.4 Scan Channel List

Choosing the best Wi-Fi channel on your router helps to reduce interference and improve your Wi-Fi connectivity. If you know that some channels are not used, then uncheck them. This eliminates searching for channels that either are not used and saves time when connecting to a network.

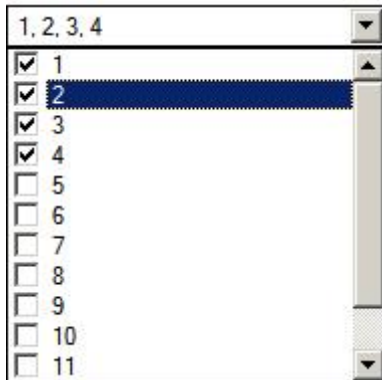

18.1.5 Security Mode

Different types of wireless security guard your network against possible instances of unauthorized access. Using security, you can:

- Ensure that no one can easily connect to your wireless network without permission
- Personalize access regarding who can configure your wireless settings
- Protect all data that is transmitted through the wireless network

Check with your system administrator for the wireless security mode you should use.

Use the drop-down menu to select the type of security:

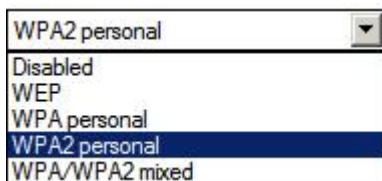

Then set your Security Key.

18.1.6 Security Key

Depending on the type of security you choose, your key will have to be a different number of characters. Here are characteristics of the different types, their relative security strength, and the number of characters needed in the key:

Security Type	Security Rank	Number of Characters
WEP (Wired Equivalent Protocol)	Basic	40/64-bit (10 characters) 128-bit (26 characters)
WPA Personal Wi-Fi Protected Access Personal	Strong	8 to 63 characters
WPA2 Personal Wi-Fi Protected Access 2 Personal	Strongest	8 to 63 characters
WPA2/WPA Mixed Mode	WPA2: Strongest WPA: Strong	8 to 63 characters

Warning! Using a network with security disabled is not recommended.

18.1.7 SSID

The SSID (Service Set Identifier) is a case-sensitive unique identifier attached to the header of packets sent over a wireless local-area network. Each wireless network in your range will have its own SSID. Consult with your IT department for the SSID.

18.1.8 Location Anchor SSID

This field is similar to the SSID field. LocaXion Anchors are shipped pre-configured with the SSID "LocaXion_Anchor". Refer to the LocaXion Anchor manual to change this SSID.

18.1.9 ProRAE Guardian IP

This is the destination IP address for the instrument to communicate via UDP (User Datagram Protocol) with a computer running ProRAE Guardian.

18.1.10 ProRAE Guardian UDP Port

ProRAE Guardian's UDP uses an IP address for the destination host and a port number to identify the destination application. The UDP port number is distinct from any physical port on a computer such as a COM port or an I/O port address. It is a 16-bit address that exists only for the purpose of passing certain types of datagram information to the correct location above the transport layer of the protocol stack.

18.2 Configuring Messaging

Select “Messaging” from the list.

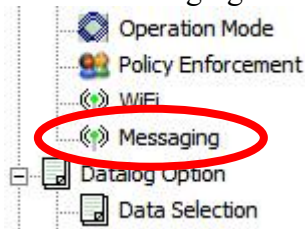

The Messaging pane is shown. You can input up to 10 messages to be sent from the Wi-Fi-equipped instrument.

After your Wi-Fi-equipped instrument has accepted the new settings, disconnect the USB cable from the instrument and computer, and exit Communications Mode on the instrument by pressing [Y/+].

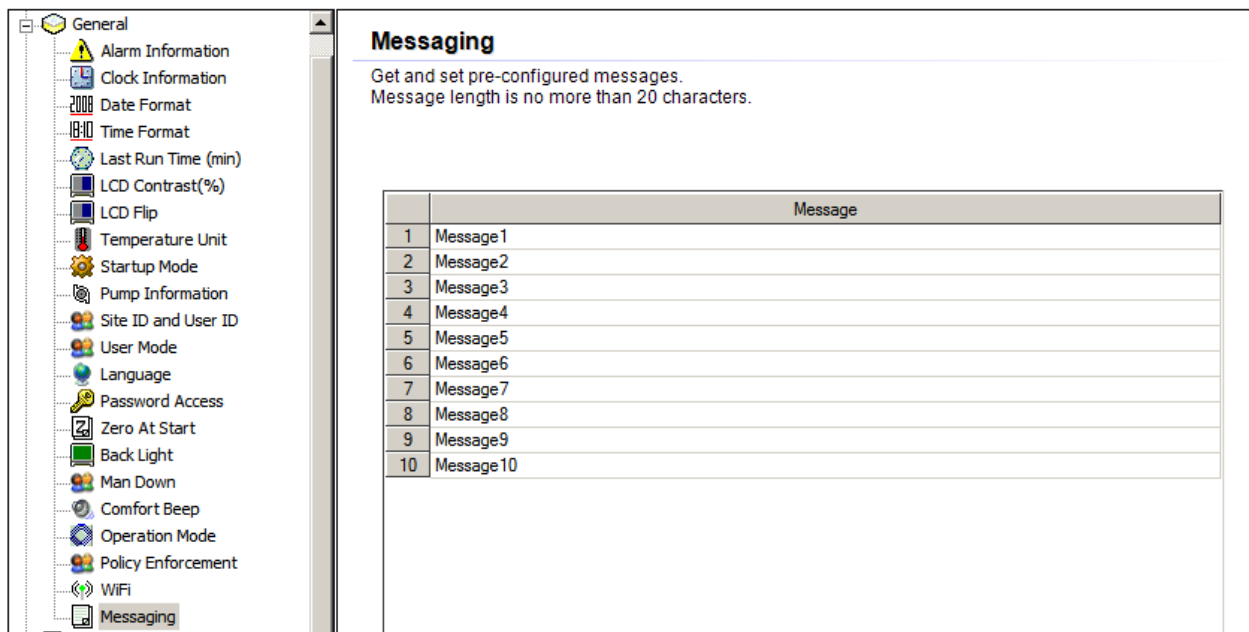

Note: Your messages are limited to 20 characters each, including spaces and hyphens. Text is automatically divided into lines at word spaces and hyphen characters. Therefore, you should include word spaces or hyphens. Otherwise, it cannot create a new line when necessary.

Note: When you type a message, it will not accept more characters after you reach the 20-character maximum.

When you are done making changes to the configuration for Wi-Fi and Messages, upload your changes to your Wi-Fi-equipped instrument. Click this icon to send the new settings to the instrument:









19 Specifications

Size	7.6" H x 3.8" W x 2.6" D (193 x 96.5 x 66 mm)
Weight (without RAE-Sep Tube Cartridge attached)	Pumped models: 31 oz. (880 g) Diffusion models: 26.8 oz. (760 g)
Sensor	Over 25 intelligent interchangeable field-replaceable sensors, including Gamma radiation, ppb and ppm PIDs, electrochemicals for toxics and oxygen, combustible LEL and NDIR, and CO ₂ NDIR
Battery Options	<ul style="list-style-type: none"> • Rechargeable Li-ion (over 12 hours runtime, pumped/over 18 hours, diffusion; < 6 hours recharge time) • Extended-duration rechargeable Li-ion (over 18 hours runtime, pumped; over 27 hours, diffusion) • Alkaline adapter for 4 x AA batteries (approximately 6 hours runtime, pumped/ 8 hours, diffusion)
Display	<ul style="list-style-type: none"> • Monochrome graphical LCD display (128 x 160) with backlighting (activated automatically in dim ambient lighting conditions, when monitor is in alarm, or with a button press) • Automatic screen flipping.
Display Readout	<ul style="list-style-type: none"> • Real-time reading of gas concentrations; PID measurement gas and correction factor; battery status; datalogging on/off; wireless on/off and reception quality. • STEL, TWA, peak, and minimum values • Various instrument status-related information
Keypad	3 operation and programming keys (MODE, Y/+, and N/-)
Sampling	Built-in pump or diffusion. Average flow rate, pumped: 250 cc/min. Auto shutoff in low-flow conditions
Calibration	Automatic with AutoRAE 2 Test and Calibration Station or manual
Alarms	<ul style="list-style-type: none"> • Wireless remote alarm notification; multi-tone audible (95 dB @ 30 cm), vibration, visible (flashing bright red LEDs), and on-screen indication of alarm conditions • Man Down Alarm with pre-alarm and real-time remote wireless notification
Datalogging	<ul style="list-style-type: none"> • Continuous datalogging (six months for 5 sensors at 1-minute intervals, 24/7) • User-configurable datalogging interval (from 1 to 3,600 seconds)
Communication and Data Download	<ul style="list-style-type: none"> • Data download and instrument set-up and upgrades on PC via charging and PC communication cradle, Travel Charger, or AutoRAE 2 Automated Test and Calibration Station¹ • Wireless data and status transmission via built-in RF modem (optional)
Wireless Network	Mesh RAE Systems Dedicated Wireless Network (or Wi-Fi network for Wi-Fi-equipped instruments)
Wireless Frequency	ISM license-free band, 868 MHz or 900 MHz FCC Part 15, CE R&TTE, ANATEL IEEE 802.11 b/g bands (2.4 GHz)
EM Immunity	No effect when exposed to 0.43mW/cm ² RF interference (5-watt transmitter at 12")
Operating Temperature	-4° to 122° F (-20° to 50° C) Benzene-specific measurement operating range: 32° to 122° F (0° to 50° C)

Specifications

Continued

Humidity	0% to 95% relative humidity (non-condensing)
Dust and Water Resistance	IP-65 (pumped), IP-67 (diffusion)
Hazardous Location Approvals	<p> Exia Class I, Division 1, Groups A, B, C, D, T4; Class II, Division 1, Groups E, F, G; T85°C</p> <p>SIRA 11ATEX2152X,  2460  II 1G Ex ia IIC T4 Ga,  I M1 Ex ia I Ma (for PGM62x0/PGM62x6)</p> <p>SIRA 11ATEX2152X,  2460  II 2G Ex ia d IIC T4 Gb,  I M1 Ex ia I Ma (for PGM62x8)</p> <p>UM=20V</p> <p>IECEX SIR 11.0069X, Ex ia IIC T4 Ga, Ex ia I Ma (for PGM62x0/PGM62x6)</p> <p>IECEX SIR 11.0069X, Ex ia d IIC T4 Gb, Ex ia I Ma (for PGM62x8)</p> <p>IECEX TSA 13.0021X / ANZEx 13.3023X</p> <p>Ex ia IIC T4 Ga</p> <p>Ex ia I Ma (PGM62x0/PGM62x6)</p> <p>Ex ia d IIC T4 Gb</p> <p>Ex ia I Ma (PGM62x8)</p>
CE Compliance (European Conformity)	EMC directive: 2004/108/EC R&TTE directive: 1999/5/EC ATEX directive: 94/9/EC
FCC Compliance	FCC Part 15
Performance Tests	LEL CSA C22.2 No. 152; ISA-12.13.01 MIL-STD-810G and 461F compliant.
Languages	Arabic, Chinese, Czech, Danish, Dutch, English, French, German, Indonesian, Italian, Japanese, Korean, Norwegian, Polish, Portuguese, Russian, Spanish, Swedish, and Turkish
Warranty	<ul style="list-style-type: none"> • Four years for Liquid O₂ sensors • Three years on CO and H₂S sensors • Two years on non-consumable components and catalytic LEL and O₂ sensors • Six months for 9.8eV lamp PID sensor • One year on all other sensors, battery, and other consumable parts

Specifications are subject to change.

Brazil Radio Specifications

Radio model: RM900A

Frequency range: Within 902 to 907.5 MHz and 915 to 928 MHz, use IEEE 802.15.4 channel 1, 6, 7, 8, 9 and 10

Modulation: 802.15.4 DSSS BPSK

RF power(Tx): 20dBm

Data rate: 40kbps

Wireless Approval For UAE In Middle East

TRA REGISTERED No: ER36636/15

DEALER No: HONEYWELL INTERNATIONAL MIDDLE EAST - LTD - DUBAI BR

Wireless Approval for QATAR In Middle East

ictQATAR

Type Approval Reg. No.: R4697

Sensor Specifications

Radiation Sensor	Range	Resolution
Gamma	0 to 20,000 μ Rem/h	1 μ Rem/h
PID Sensors	Range	Resolution
VOC 10.6 eV (HR)	0.1 to 5,000 ppm	0.1 ppm
VOC 10.6 eV (LR)*	1 to 1,000 ppm	1 ppm
VOC 10.6 eV (ppb)	10 ppb to 2,000 ppm	10 ppb
VOC 9.8eV for use in TVOC mode***	0.1 to 2,000 ppm	0.1 ppm
VOC 9.8eV for use in Benzene mode (requires RAE-Sep Tube Cartridge)***	0.1 to 200 ppm	0.1 ppm
Combustible Sensors	Range	Resolution
Catalytic bead LEL	0 to 100% LEL	1% LEL
NDIR (0-100% LEL Methane)	0 to 100% LEL	1% LEL
NDIR (0-100% Vol. Methane)	0 to 100% Vol.	0.1% Vol.
Carbon Dioxide Sensor	Range	Resolution
Carbon Dioxide (CO ₂) NDIR	0 to 50,000 ppm	100 ppm
Electrochemical Sensors	Range	Resolution
Ammonia (NH ₃)	0 to 100 ppm	1 ppm
Carbon Monoxide (CO)	0 to 500 ppm	1 ppm
Carbon Monoxide (CO), Ext. Range	0 to 2,000 ppm	10 ppm
Carbon Monoxide (CO), H ₂ -comp.	0 to 2,000 ppm	10 ppm
Carbon Monoxide (CO) + Hydrogen Sulfide (H ₂ S) Combo	0 to 500 ppm 0 to 200 ppm	1 ppm 0.1 ppm
Chlorine (Cl ₂)	0 to 50 ppm	0.1 ppm
Chlorine Dioxide (ClO ₂)	0 to 1 ppm	0.03 ppm
Ethylene Oxide (EtO-A)	0 to 100 ppm	0.5 ppm
Ethylene Oxide (EtO-B)	0 to 10 ppm	0.1 ppm
Ethylene Oxide (EtO-C), Ext. Range**	0 to 500 ppm	10 ppm
Formaldehyde (HCHO)	0 to 10 ppm	0.01 ppm
Hydrogen (H ₂)**	0 to 1,000 ppm	10 ppm
Hydrogen Sulfide	0 to 100 ppm	0.1 ppm
Hydrogen Sulfide (H ₂ S), Ext. Range**	0 to 1,000 ppm	1 ppm
Hydrogen Cyanide (HCN)	0 to 50 ppm	0.5 ppm
Methyl Mercaptan (CH ₃ -SH)	0 to 10 ppm	0.1 ppm
Nitric Oxide (NO)	0 to 250 ppm	0.5 ppm
Nitrogen Dioxide (NO ₂)	0 to 20 ppm	0.1 ppm
Oxygen (O ₂)	0 to 30% Vol.	0.1% Vol.
Oxygen (O ₂) Liquid	0 to 30% Vol.	0.1% Vol.
Phosphine (PH ₃)	0 to 20 ppm	0.1 ppm
Phosphine (PH ₃), allows H ₂ S cross-calibration	0 to 20 ppm	0.1 ppm
Sulfur Dioxide (SO ₂)	0 to 20 ppm	0.1 ppm

* Supported in MultiRAE Lite Pumped version only.

** Supported in Diffusion version only.

*** Supported in MultiRAE Benzene only.

Note: Not all sensors listed are supported by all MultiRAE models.

All specifications are subject to change without notice.

LEL Range, Resolution & Response Time

LEL 0-100% 1 % 15 sec

LEL Correction Factors

Compound	LEL Relative Sensitivity*	LEL CF
Methane	100	1.0
Propane	62	1.6
Propene	67	1.5
n-Butane	50	2.0
Isobutylene	67	1.5
n-Pentane	45	2.2
n-Hexane	43	2.3
Cyclohexane	40	2.5
Benzene	45	2.2
Toluene	38	2.6
n-Heptane	42	2.4
n-Octane	34	2.9
Turpentine	34	2.9
Leaded Gasoline	48	2.1
Methanol	67	1.5
Ethanol	59	1.7
Isopropanol	38	2.6
Acetone	45	2.2
Methyl Ethyl Ketone	38	2.6
Ethyl Acetate	45	2.2
Carbon Monoxide	75	1.2
Hydrogen	91	1.1
Ammonia	125	0.80

* Response of the RAE Systems LEL sensor to a range of gases at the same LEL, expressed as percent of methane response (=100). These figures are for guidance only and are rounded to the nearest 5%. For the most accurate measurements, the instrument should be calibrated with the gas under investigation. See RAE Systems Technical Note TN-156 for more details and other compounds.

Caution:

Refer to RAE Systems Technical Note TN-144 for LEL sensor poisoning.

Year Of Manufacture

To identify the year of manufacture, refer to the serial number of the instrument.

The second to last digit in the serial number indicates the year of manufacture. For example, “M” indicates the manufacturing year is 2010.

First digit	Year
J	2008
K	2009
M	2010
N	2011
P	2012
Q	2013
R	2014
S	2015
T	2016
U	2017
V	2018
W	2019

20 Technical Support

To contact RAE Systems Technical Support Team:

Monday through Friday, 7:00AM to 5:00PM Pacific (US) Time

Phone (toll-free): +1 888-723-4800

Phone: +1 408-952-8461

E-mail: RAE-tech@honeywell.com

Web Site: www.raesystems.com, www.honeywellanalytics.com

Outside the Americas:

E-Mail: HAexpert@honeywell.com



For more information

www.honeywellanalytics.com

www.raesystems.com

Europe, Middle East, Africa

Life Safety Distribution GmbH

Tel: 00800 333 222 44 (Freephone number)

Tel: +41 44 943 4380 (Alternative number)

Fax: 00800 333 222 55

Middle East Tel: +971 4 450 5800

(Fixed Gas Detection)

Middle East Tel: +971 4 450 5852

(Portable Gas Detection)

gasdetection@honeywell.com

Americas

Honeywell Analytics

Distribution Inc.

Tel: +1 888 749 8878

Fax: +1 817 274 8321

detectgas@honeywell.com

Honeywell RAE Systems

Phone: 408 952 8200

Toll Free: 1 888 723 4800

Fax: 408 952 8480

Asia Pacific

Honeywell Analytics Asia Pacific

Tel: +82 (0) 2 6909 0300

Fax: +82 (0) 2 2025 0328

India Tel: +91 124 4752700

analytics.ap@honeywell.com

Technical Services

EMEA: HAexpert@honeywell.com

US: ha.us.service@honeywell.com

AP: ha.ap.service@honeywell.com

Rev J
September 2017
P/N: M01-4003-000